



PT0E-1362

**Portable Multi-Gas Monitor**  
**RX-8500/RX-8700**  
**Operating Manual**  
**(PT0-136)**

**RIKEN KEIKI Co., Ltd.**

**2-7-6 Azusawa, Itabashi-ku, Tokyo, 174-8744, Japan**

**Phone : +81-3-3966-1113**

**Fax : +81-3-3558-9110**

**E-mail : [intdept@rikenkeiki.co.jp](mailto:intdept@rikenkeiki.co.jp)**

**Web site : <http://www.rikenkeiki.co.jp/english/>**

# Contents

Outline of the Product .....	4
Preface.....	4
Purpose of use.....	4
Definition of DANGER, WARNING, CAUTION and NOTE.....	5
Important Notices on Safety.....	6
2-1. Danger cases .....	6
2-2. Warning cases .....	8
2-3. Precautions.....	9
2-4. Safety Information .....	11
Product Components .....	12
3-1. Main unit and standard accessories .....	12
Main unit.....	12
Accessories.....	13
3-2. Names and functions for each part.....	16
<RX-8500 (with lithium ion battery unit BUL-8000)>.....	16
<RX-8700 (with lithium ion battery unit BUL-8000)>.....	19
How to Use .....	23
4-1. Before using the gas monitor .....	23
4-2. Preparation for start-up .....	23
4-2-1. Charging the lithium ion battery unit (BUL-8000).....	24
4-2-2. Detaching and attaching the battery unit .....	25
4-2-3. Attaching batteries to the dry battery unit (BUD-8000, option).....	26
4-2-4. Connecting the gas sampling probe and gas sampling hoses .....	27
4-3. How to start the gas monitor .....	29
4-3-1. Power-on .....	29
4-3-2. Switching the hydrogen sulfide measuring mode range on RX-8700 .....	31
4-4. Basic operating procedures .....	32
4-4-1. RX-8500 basic operating procedures .....	32
4-4-2. RX-8700 basic operating procedures .....	33
4-5. Measurement .....	34
4-5-1. Gas concentration measurement.....	34
4-5-2. Range switching point .....	36
4-6. Air calibration.....	37
4-6-1. Attaching the CO <sub>2</sub> removal filter (RX-8500) .....	37
4-6-2. Air calibration procedure .....	38
4-7. Manual memory.....	41
4-8. Stopping the pump (PUMP OFF mode).....	42
4-9. Power-off .....	43
Setting Procedure .....	44
5-1. Display/setting mode.....	44
5-2. PEAK display/clear.....	46
5-3. Full scale/alarm setpoint display/gas alarm test (optional function).....	47
5-4. Station ID display .....	48
5-5. Log data display .....	49
Fault Alarm Function .....	50
6-1. Fault alarm activation .....	50
7. Maintenance.....	52
7-1. Maintenance intervals and items .....	52
About maintenance services.....	53
7-2. Span adjustment .....	54
7-2-1. Preparation .....	54
7-2-2. How to connect.....	54
7-2-3. Span adjustment procedure .....	55
7-3. How to clean.....	58
7-4. Parts replacement .....	59
7-4-1. Sensor replacement .....	59
7-4-2. Replacement procedure for gas sampling probe dust filter .....	59
7-4-3. Replacement procedure for filter tube dust filter.....	60
7-4-4. Replacement procedure for filter tube absorbent cotton .....	60
7-4-5. Replacement of regular replacement parts.....	61

Storage and Disposal.....	62
8-1. Procedures to store the gas monitor or leave it for a long time.....	62
8-2. Procedures to use the gas monitor again.....	62
8-3. Disposal of products.....	63
Troubleshooting.....	64
9-1. Abnormalities on unit.....	64
9-2. Abnormalities of readings.....	66
Product Specifications.....	67
10-1. RX-8500 specifications.....	67
10-1-1. List of RX-8500 specifications.....	67
10-1-2. RX-8500 standard accessories.....	68
10-2. RX-8700 specifications.....	69
10-2-1. List of RX-8700 specifications.....	69
10-2-2. RX-8700 standard accessories.....	70
10-3. List of optional items.....	71
Appendix.....	72
11-1. Definition of terms.....	72
11-2. Calibration history/various trend/event history functions.....	72
11-3. Gas alarm (optional function).....	74

## 1

# Outline of the Product

## Preface

Thank you for choosing our portable multi-gas monitor RX-8500/RX-8700 (hereinafter referred to as "gas monitor"). Please check that the model number of the product you purchased is included in the specifications on this manual.

This manual describes how to use the monitor properly and its specifications. Not only the first-time users but also the users who have already used the gas monitor must read and understand the operating manual and use this product as described in this manual.

Note that the contents of this manual are subject to change without notice for product improvement. Also, any copying or reproduction of this manual, in whole or in part, without permission is prohibited.

Regardless of warranty period, we shall not make any indemnification for accidents and damage caused by using the gas monitor.

Make sure to read the warranty policy specified on the warranty.

## Purpose of use

This product is a portable gas monitor capable of measuring multiple gases alone, which is required in LNG carriers or oil tankers. Measurable gases and ranges are shown below.

### <RX-8500>

Measuring gas	Measuring range <Service range>
Combustible gas (CH <sub>4</sub> )	0 - 100.0% LEL/5 - 100.0 vol%
Oxygen (O <sub>2</sub> )	0 - 25.0% <25.1 - 40.0%>
Carbon monoxide (CO)	0 - 1000 ppm
Carbon dioxide (CO <sub>2</sub> )	0 - 20.0 vol%

### <RX-8700>

Measuring gas	Measuring range <Service range>
Combustible gas (HC)*	0 - 100.0% LEL/2 - 100.0 vol%
Oxygen (O <sub>2</sub> )	0 - 25.0% <25.1 - 40.0%>
Hydrogen sulfide (H <sub>2</sub> S) [Low concentration]	0 - 30.0 ppm <30.5 - 100.0 ppm>
[High concentration]	0 - 1000 ppm

\* HC: Isobutane converted

RX-8500 is capable of measuring CH<sub>4</sub> (methane) as combustible gas, whereas RX-8700 is capable of measuring general combustible gases HC (isobutane converted).



Note that measurement results of the gas monitor are not intended to guarantee life or safety in any way.

Check the specifications before use and conduct gas measurement properly in accordance with purposes.

In addition to this operating manual, an operating manual for the data logger management program (option) is available for the gas monitor. Please contact RIKEN KEIKI if it is needed.

## Definition of DANGER, WARNING, CAUTION and NOTE

Throughout this manual, the following indications are used to ensure safe and effective work.

 <b>DANGER</b>	This message indicates that improper handling may cause serious damage on life, health or assets.
 <b>WARNING</b>	This message indicates that improper handling may cause serious damage on health or assets.
 <b>CAUTION</b>	This message indicates that improper handling may cause minor damage on health or assets.
<b>NOTE</b>	This message indicates advice on handling.

## 2

# Important Notices on Safety

To maintain the performance and use the gas monitor safely, observe the following instructions of DANGER, WARNING and CAUTION.

## 2-1. Danger cases



### DANGER

#### About explosion-proof

- Do not modify or change the circuit, structure, etc.
- When using the gas monitor in a hazardous area, take the following countermeasures for preventing dangers resulting from electrostatic charges.
  - (1) Wear anti-static clothes and conductive shoes (anti-static work shoes).
  - (2) For indoor use, use the gas monitor while standing on a conductive work floor (with a leakage resistance of 10 MΩ or less).
- [RX-8500, RX-8700] When measuring the oxygen concentration, do not measure anything but a mixture of air and combustible gases or vapors and toxic gases.
- [RX-8500, RX-8700] Connect either the dry battery unit BUD-8000(Z)(TC21187) or lithium ion battery unit BUL-8000(Z1)(TC21188).
- [BUD-8000(Z), BUL-8000(Z1)] Connect either RX-8500 or RX-8700(TC21186) unit.
- [BUD-8000(Z), BUL-8000(Z1)] Replace the battery unit in a safe place.
- [BUL-8000(Z1)] Charge the battery unit using the dedicated AC adapter in a safe place.
- [BUL-8000(Z1)] Charge the battery unit at ambient temperatures between 0 to 40°C.
- [BUD-8000(Z)] Replace the batteries in a safe place.
- [BUD-8000(Z)] The explosion-proof standard for the gas monitor requires the use of TOSHIBA dry batteries. Use three AA alkaline batteries (LR6) produced by TOSHIBA CORPORATION to use the gas monitor as an explosion-proof unit.
- The specifications of RX-8500 and RX-8700 are as follows:
 

Pump circuit	: Allowable voltage of 4.95 V, allowable current of 1.12 A and allowable power of 1138 mW
Infrared detection circuit	: Allowable voltage of 4.95 V, allowable current of 0.834 A and allowable power of 853 mW
Buzzer circuit	: Allowable voltage of 4.95 V, allowable current of 0.431 A and allowable power of 441 mW
Main circuit	: Allowable voltage of 4.95 V, allowable current of 0.717 A and allowable power of 733 mW
Backup circuit	: 3.0 VDC, 10 μA
Ambient temperature	: -20 - +50°C



## DANGER

### About explosion-proof

- The specifications of BUL-8000(Z1) are as follows:
  - Pump circuit : Maximum voltage of 4.25 V, maximum current of 1.12 A and maximum power of 901 mW
  - Infrared detection circuit : Maximum voltage of 4.25 V, maximum current of 0.768 A and maximum power of 618 mW
  - Buzzer circuit : Maximum voltage of 4.25 V, maximum current of 0.410 A and maximum power of 330 mW
  - Main circuit : Maximum voltage of 4.25 V, maximum current of 0.653 A and maximum power of 526 mW
  - Battery charging contact : Allowable voltage of 250 VAC, 50/60 Hz
  - Ambient temperature : -20 - +50°C
- The specifications of BUD-8000(Z) are as follows:
  - Pump circuit : Maximum voltage of 4.95 V, maximum current of 1.12 A and maximum power of 1138 mW
  - Infrared detection circuit : Maximum voltage of 4.95 V, maximum current of 0.834 A and maximum power of 853 mW
  - Buzzer circuit : Maximum voltage of 4.95 V, maximum current of 0.431 A and maximum power of 441 mW
  - Main circuit : Maximum voltage of 4.95 V, maximum current of 0.717 A and maximum power of 733 mW
  - Power supply : 4.5 V 150 mA (LR6 produced by TOSHIBA, 3 pcs)
  - Ambient temperature : -20 - +50°C
- Make sure that the product model on the nameplate is correct.  
Inappropriate combinations of models deviate from the range of explosion-proof certification.
- The nameplate shows the followings as well as the product model.
  - Product model : Main unit: RX-8500, 8700  
Lithium ion battery unit: BUL-8000(Z1)  
Dry battery unit: BUD-8000 (Z)
  - Explosion proof class : 【RX-8500,8700】Ex ia IIC T4X  
【BUL-8000(Z1), BUD-8000(Z)】 Ex ia IIC T4
  - Ambient temperature : -20 to 50°C
  - Charging terminal rating : 【BUL-8000(Z1)】Allowable voltage AC250V 50/60Hz
  - Warnings : 【BUL-8000(Z1), BUD-8000(Z)】  
Inhibit to take off battery unit in non-hazardous area.
- Manufacturer : RIKEN KEIKI Co., Ltd.
- IP protection class: IP20

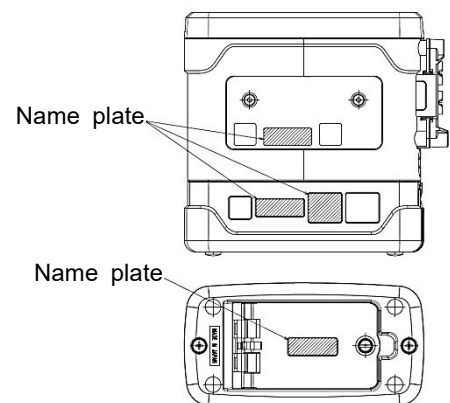

### About use

- While conducting measurement in a manhole or confined space, do not lean over or look into the manhole or confined space. It may lead to dangers because oxygen-deficient air or other gases may blow out.
- Oxygen-deficient air or other gases may be discharged from the gas exhausting outlet (GAS OUT). Never inhale the air or gases.
- High-concentration (100% LEL or higher) gases may be discharged. Never use fire near it.

## 2-2. Warning cases



### WARNING

#### Sampling point pressure

- The concentration meter is designed to draw gases under the atmospheric pressure. If excessive pressure is applied to the gas inlet (GAS IN) and outlet (GAS OUT) of the gas monitor, measured gases may leak out from its inside and may cause dangerous conditions. Be sure that excessive pressure is not applied to them while used.
- Do not connect the gas sampling hose directly to a location with a pressure higher than the atmospheric pressure. The internal piping system may be damaged.

#### Handling of sensor

- Do not disassemble the carbon monoxide, hydrogen sulfide or oxygen sensor inside the gas monitor because it contains electrolyte. Electrolyte may cause severe skin burns if it contacts skin, while it may cause blindness if its contacts eyes.  
If electrolyte is adhered on your clothes, that part on your clothes is discolored or its material is decomposed. If contact occurs, rinse the area immediately with a large quantity of water.

#### Air calibration in atmosphere

- When air calibration is performed in the atmosphere, check the atmosphere for freshness before beginning it. If interference gases exist, air calibration cannot be performed properly, thus causing erroneous measurement and leading to dangers when the gas leaks.

#### Battery level check

- Before use, check that there remains sufficient battery power. When the gas monitor is used for the first time or is not used for a long period, the batteries may be exhausted. Replace them with new ones before use.
- If a low battery voltage alarm is triggered, gas measurement cannot be conducted. If the alarm is triggered during use, turn off the power and promptly replace the batteries in a safe area.

#### Others

- Do not throw the gas monitor into fire.
- Do not wash the gas monitor in a washing machine or ultrasonic cleaner.
- Do not block the buzzer sound opening. No alarm sound can be heard.
- Do not remove batteries while the power is on.
- Do not vibrate or give a shock to the gas monitor by, for example, relocating the gas monitor with an optional water trap attached. The gas inlet (GAS IN) may be damaged.

## 2-3. Precautions



### CAUTION

**Do not use the gas monitor in a place where it is exposed to oil, chemicals, etc. Do not submerge the gas monitor under water on purpose.**

- Do not use in a place where the gas monitor is exposed to liquids such as oil and chemicals.
- The gas monitor is not water-pressure-resistant. Avoid using it in a place where a high water pressure is applied to it (under a faucet, shower, rainfall, etc.) or submerging it under water for a long time. Note that the gas monitor is water-proof only in fresh water and running water, and not in hot water, salt water, detergent, chemicals, human sweat, etc.
- The gas inlet (GAS IN) and outlet (GAS OUT) are not water-proof. Be careful not to let water such as rainwater get into these parts. Because this may cause trouble and gas cannot be measured.
- Do not place the gas monitor where water or dirt gets accumulated. The gas monitor placed at such a location may malfunction due to water or dirt that gets into the buzzer sound opening, gas inlet (GAS IN), etc.
- Note that drawing in dirty water, dust, metallic powder, etc. will significantly deteriorate the sensor sensitivities. Be careful when the gas monitor is used in an environment where these elements exist.

**Do not use the gas monitor in a place where the temperature drops below -20°C or rises over 50°C.**

- The operating temperature of the gas monitor is -20 to +50°C. Do not use the gas monitor at higher temperatures, humidities and pressures or at lower temperatures than the operating range.
- Avoid long-term use of the gas monitor in a place where it is exposed to direct sunlight.
- Do not store the gas monitor in a sun-heated car.

**Observe the operating restrictions to prevent condensation inside the gas monitor or gas sampling hose.**

- Condensation formed inside the gas monitor or gas sampling hose causes clogging or gas adsorption, which may disturb accurate gas measurement. Thus, condensation must be avoided. In addition to the installation environment, carefully monitor the temperature/humidity of the sampling point to prevent condensation inside the gas monitor. Please observe the operating restrictions.

**Do not use a transceiver near the gas monitor.**

- Radio wave from a transceiver or the like near the gas monitor may disturb the readings. If a transceiver or other radio wave transmitting device is used, it must be used in a place away from the gas monitor where it disturbs nothing.
- Do not use the gas monitor near a device that emits strong electromagnetic waves (high-frequency or high-voltage devices).

**Verify that the pump driving indicator is rotating before using the gas monitor**

- If the pump driving indicator is not rotating, gas measurement cannot be performed properly. Check whether the flow rate is lost.

**Never fail to perform a regular maintenance.**

- The gas monitor is a safety unit. Never fail to perform regular maintenance. Continuing to use the gas monitor without performing maintenance will compromise the sensitivity of the sensor, thus resulting in inaccurate gas measurement.



## CAUTION

### Others

- Pressing buttons unnecessarily may change the settings, preventing alarms from activating correctly. Operate the gas monitor using only the procedures described in this operating manual.
- Do not drop or give shock to the gas monitor. The accuracy of the gas monitor may be deteriorated.
- Do not use the gas monitor while charging it.
- Whereas the gas monitor can measure combustible gases, carbon monoxide, carbon dioxide, hydrogen sulfide and oxygen, the measurement environment may include gases that have harmful effects on the sensors of this unit.
- When measuring concentrations of oxygen in inert gases for a long time, the carbon dioxide concentration in the air must be 15 vol% or less. When the gas monitor is used in the inert gas with a carbon dioxide concentration higher than 15 vol%, perform measurement in as short time as possible.
- Do not use the gas monitor in a place with high oxygen concentration for a long time. The oxygen sensor life may be shortened.
- Do not jab the buzzer sound opening with a sharp-pointed item. The gas monitor may malfunction or get damaged, allowing foreign matter, etc. to get inside.
- Do not remove the panel sheet on the LCD display. The dust-proof performance will be deteriorated.
- Do not affix a label or the like on the infrared port. Infrared communications can no longer be conducted.

### Replacement of batteries

- Turn off the power of the gas monitor before replacing the batteries.
- Replace all of the three batteries with new ones at one time.
- The explosion-proof standard for the gas monitor requires the use of TOSHIBA dry batteries (only when the dry battery unit is used). Use three AA alkaline batteries (LR6) produced by TOSHIBA CORPORATION to use the gas monitor as an explosion-proof unit.
- Pay attention to the polarities of the batteries.

### Usage

- In a low-temperature environment, the operating time is shortened due to the battery performance property.
- At low temperatures, the responses of the LCD display may slow down.
- Perform air calibration under pressure and temperature/humidity conditions close to those in the operating environment and in fresh air.
- Perform air calibration after the reading is stabilized.
- If there is a sudden temperature change of 15°C or more between the storage and operational locations, turn on the power of the gas monitor, let it stand for about 10 minutes in a similar environment to the operational location, and perform air calibration in fresh air before using it.
- When cleaning the gas monitor, do not splash water over it or use organic solvents such as alcohol and benzene on it. The surface of the gas monitor may be discolored or damaged.
- If the gas monitor is not used for a long time, turn on the power at least once every six months and check that the pump draws in air (about three minutes). The gas monitor, when not activated for a long time, may cease to work because of hardening of the grease in the pump motor.
- If the gas monitor is not used for a long time, store it after removing the batteries. Battery leaks may result in fire, injury, etc.
- When using the gas monitor after long-term storage, never fail to perform air calibration. For information on readjustment including air calibration, please contact RIKEN KEIKI.

## 2-4. Safety Information

The Portable Gas Detector Model RX-8500/8700 is a gas monitors designed to provide continuous exposure monitoring of combustible gas, Oxygen (O<sub>2</sub>), toxic gas such as carbon monoxide (CO), Carbon Dioxide(CO<sub>2</sub>), and hydrogen sulfide (H<sub>2</sub>S) in hazardous environments. The gas sampling is suctioned by build-in micro pump.

The battery can be selected either Li-ion battery or alkaline dry battery.

Li-ion battery unit is called BUL-8000(Z1) and alkaline dry battery unit is called BUD-8000(Z).

The battery unit structured even the end user is possible to replace.

### Specification for safety

•Ex ia IIC T4 Ga

•  G Ex ia IIC T4 Ga

•Ambient temperature range for use : -20°C to +50°C

•Ambient temperature range during battery charging : 0°C to +40°C

### Electrical data

•Power supply of Li-ion battery unit : BUL-8000(Z1)

Two parallel connected Li-ion cells used in battery pack BP-8000 are from type Maxell INR18650PB1 or SDI INR18650-15M or SONY US18650VT3.

Um=250V..

•Power supply of alkaline battery unit : BUD-8000(Z)

Powered by three series AA size alkaline batteries, model LR6 by TOSHIBA.

### Certificate numbers

•IECEX Certificate number : IECEX PRE 15.0012

•ATEX Certificate number : Presafe 15 ATEX6173

### List of standards

•IEC 60079-0:2011

•IEC 60079-11:2011

•IEC 60079-26:2006

•EN60079-0:2012

•EN60079-11:2012

•EN60079-26:2007

### WARNING

•DO NOT CHARGE IN HAZARDOUS LOCATION.

•DO NOT CHARGE IT EXCEPT BY GENUINE CHARGER.

•DO NOT REPLACE BATTERY UNIT IN HAZARDOUS LOCATION.

•DO NOT REPLACE DRY BATTERIES IN HAZARDOUS LOCATION.

•DO NOT ATTEMPT TO DISASSEMBLE OR ALTER THE INSTRUMENT.

•USE ONLY WITH CONNECTED ALKALINE AA BATTERY, TYPE LR6

MANUFACTURED BY TOSHIBA.

INST. No. 0 0 0 0 0 0 0 0 0 0 0 0  
                   A B C       D E

A: Manufacturing year (0-9)

B: Manufacturing month (1-9,XYZ for Oct.-Dec.)

C: Manufacturing lot

D: Serial number

E: Code of factory



### RIKEN KEIKI Co., Ltd.

2-7-6 Azusawa, Itabashi-ku, Tokyo, 174-8744, Japan

Phone : +81-3-3966-1113

Fax : +81-3-3558-9110 GIII

E-mail : [intdept@rikenkeiki.co.jp](mailto:intdept@rikenkeiki.co.jp)

Web site : <http://www.rikenkeiki.co.jp>

---

**3**

---

# Product Components

## 3-1. Main unit and standard accessories

Unpack and check the main unit and accessories.  
If any part is missing, contact RIKEN KEIKI.

### Main unit

See "Names and functions for each part" (P. 16) for names and functions of each part of the gas monitor and LCD display.

#### <RX-8500 main unit>

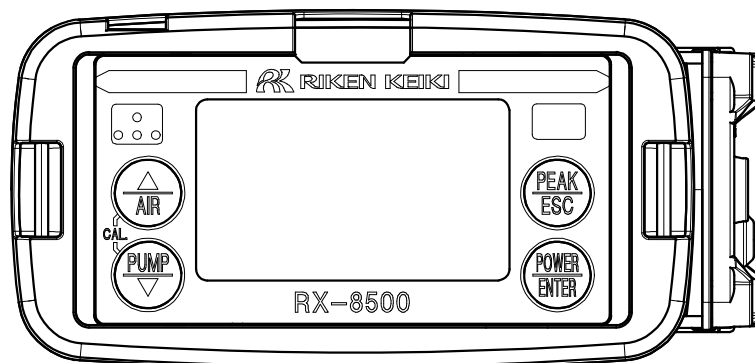

#### <RX-8700 main unit>

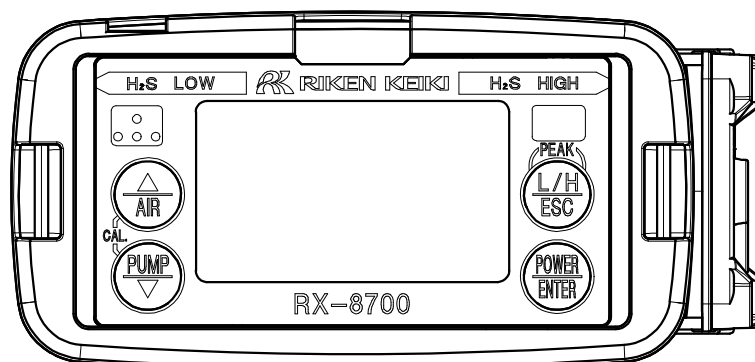

## Accessories

Lithium ion battery  
unit (BUL-8000)  
: 1 pc



AC adapter for  
charging  
: 1 pc



Filter tube and  
relay tube: 1 pc



Filter tube and  
relay tube: 1 pc



Absorbing tube fixing  
belt: 2 pcs



Shoulder strap  
: 1 pc



CO2 removal filter  
(CF-283): 1 pc  
(RX-8500 only)



Zero filter fixing belt  
: 1 pc (RX-8500 only)



Product warranty  
Operating manual



## DANGER

### About explosion-proof

- Do not modify or change the circuit, structure, etc.
- When using the gas monitor in a hazardous area, take the following countermeasures for preventing dangers resulting from electrostatic charges.
  - (1) Wear anti-static clothes and conductive shoes (anti-static work shoes).
  - (2) For indoor use, use the gas monitor while standing on a conductive work floor (with a leakage resistance of 10 MΩ or less).
- [RX-8500, RX-8700] When measuring the oxygen concentration, do not measure anything but a mixture of air and combustible gases or vapors and toxic gases.
- [RX-8500, RX-8700] Connect either the dry battery unit BUD-8000(Z)(TC21187) or lithium ion battery unit BUL-8000(Z1)(TC21188).
- [BUD-8000(Z), BUL-8000(Z1)] Connect either RX-8500 or RX-8700(TC21186) unit.
- [BUD-8000(Z), BUL-8000(Z1)] Replace the battery unit in a safe place.
- [BUL-8000(Z1)] Charge the battery unit using the dedicated AC adapter in a safe place.
- [BUL-8000(Z1)] Charge the battery unit at ambient temperatures between 0 to 40°C.
- [BUD-8000(Z)] Replace the batteries in a safe place.
- [BUD-8000(Z)] The explosion-proof standard for the gas monitor requires the use of TOSHIBA dry batteries. Use three AA alkaline batteries (LR6) produced by TOSHIBA CORPORATION to use the gas monitor as an explosion-proof unit.
- The specifications of RX-8500 and RX-8700 are as follows:
 

Pump circuit	: Allowable voltage of 4.95 V, allowable current of 1.12 A and allowable power of 1138 mW
Infrared detection circuit	: Allowable voltage of 4.95 V, allowable current of 0.834 A and allowable power of 853 mW
Buzzer circuit	: Allowable voltage of 4.95 V, allowable current of 0.431 A and allowable power of 441 mW
Main circuit	: Allowable voltage of 4.95 V, allowable current of 0.717 A and allowable power of 733 mW
Backup circuit	: 3.0 VDC, 10 μA
Ambient temperature	: -20 - +50°C
- The specifications of BUL-8000(Z1) are as follows:
 

Pump circuit	: Maximum voltage of 4.25 V, maximum current of 1.12 A and maximum power of 901 mW
Infrared detection circuit	: Maximum voltage of 4.25 V, maximum current of 0.768 A and maximum power of 618 mW
Buzzer circuit	: Maximum voltage of 4.25 V, maximum current of 0.410 A and maximum power of 330 mW
Main circuit	: Maximum voltage of 4.25 V, maximum current of 0.653 A and maximum power of 526 mW
Battery charging contact	: Maximum voltage of 250 VAC, 50/60 Hz
Ambient temperature	: -20 - +50°C
- The specifications of BUD-8000(Z) are as follows:
 

Pump circuit	: Maximum voltage of 4.95 V, maximum current of 1.12 A and maximum power of 1138 mW
Infrared detection circuit	: Maximum voltage of 4.95 V, maximum current of 0.834 A and maximum power of 853 mW
Buzzer circuit	: Maximum voltage of 4.95 V, maximum current of 0.431 A and maximum power of 441 mW
Main circuit	: Maximum voltage of 4.95 V, maximum current of 0.717 A and maximum power of 733 mW
Power supply	: 4.5 V 150 mA (LR6 produced by TOSHIBA, 3 pcs)
Ambient temperature	: -20 - +50°C



## DANGER

- Make sure that the product model on the nameplate is correct.  
Inappropriate combinations of models deviate from the range of explosion-proof certification.
- The nameplate shows the followings as well as the product model.  
Product model : Main unit: RX-8500, 8700  
Lithium ion battery unit: BUL-8000(Z1)  
Dry battery unit: BUD-8000 (Z)  
Explosion proof class : 【RX-8500,8700】Ex ia IIC T4X  
【BUL-8000(Z1), BUD-8000(Z)】 Ex ia IIC T4  
Ambient temperature : -20 to 50°C  
Charging terminal rating : 【BUL-8000(Z1)】Allowable voltage AC250V 50/60Hz  
Warnings : 【BUL-8000(Z1), BUD-8000(Z)】  
Inhibit to take off battery unit in non-hazardous area.
- Manufacturer : RIKEN KEIKI Co., Ltd.
- IP protection class: IP20

## NOTE

Connect either the dry battery unit BUD-8000(Z) or lithium ion battery unit BUL-8000(Z1).  
Check the model of the battery unit with the nameplate affixed to the unit.  
A nameplate indicating a compatible model is affixed to the battery unit to avoid using the gas monitor in combination with a wrong unit.  
Check this information and use a correct combination.

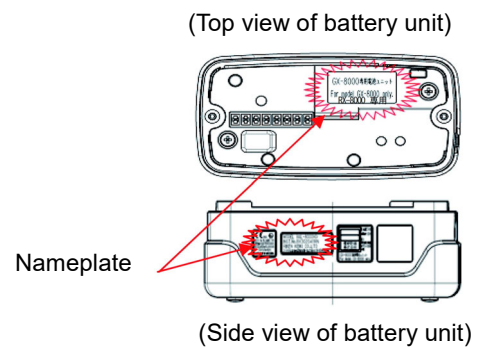

## 3-2. Names and functions for each part

This section describes names and functions of main unit and battery unit parts and LCD display.

### <RX-8500 (with lithium ion battery unit BUL-8000(Z1))>

#### <Main Unit>

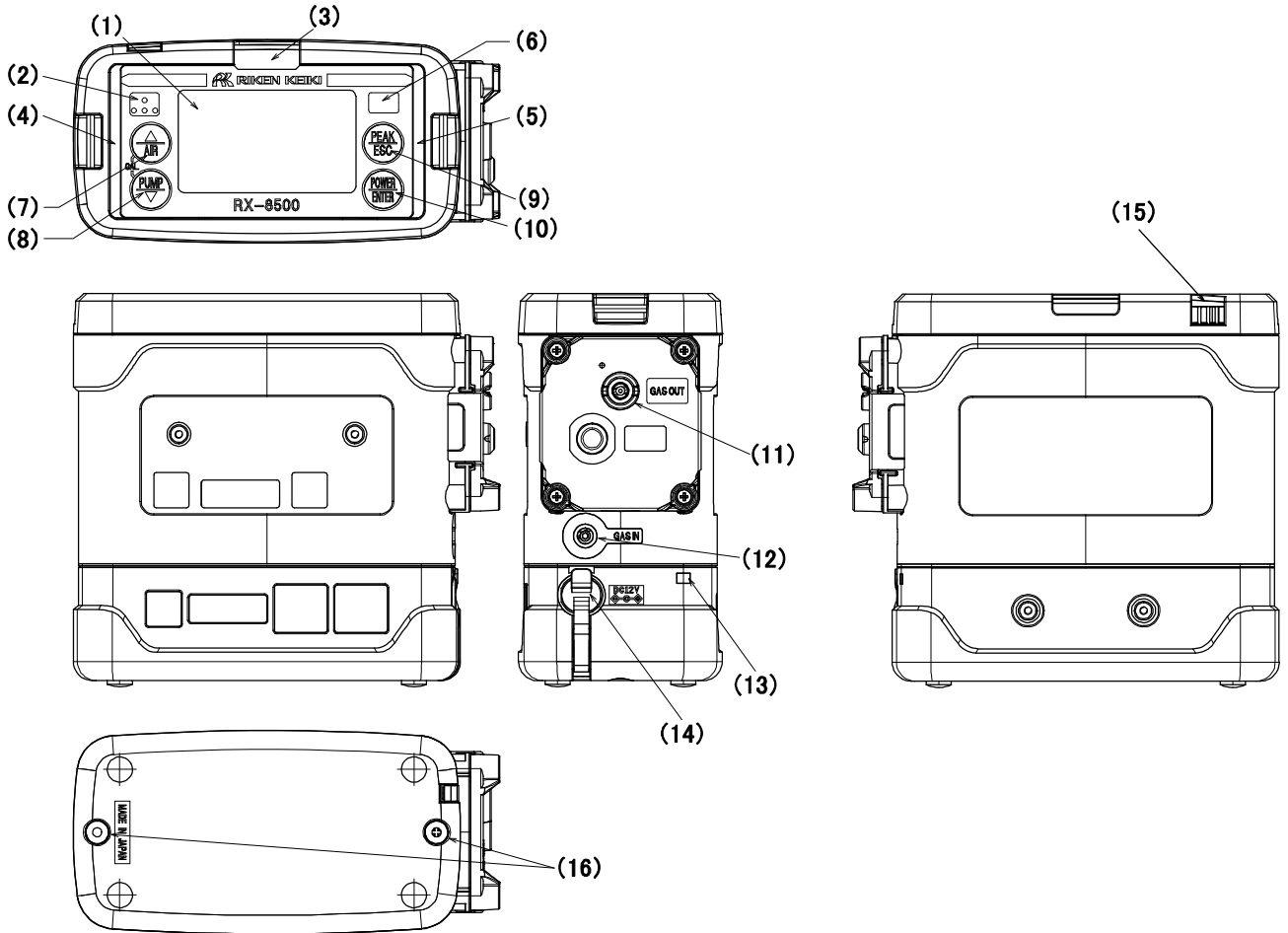

Name	Main function
(1) LCD display	Displays a gas concentration, alarm, etc.
(2) Buzzer sound opening	Emits a buzzer sound at an alarm. (Do not block it.)
(3) Alarm LED arrays (top)	The red lamp blinks in response to an alarm.
(4) Alarm LED arrays (left)	
(5) Alarm LED arrays (right)	
(6) Infrared communication port	Used to carry out data communications with a PC when the data logger management program is used.

Name	Main function
(7) ▲/AIR button	Used to perform air calibration on the measurement screen. Or used to increase a numeric value in the display/setting mode.
(8) ▼/PUMP button	Used to turn ON/OFF the pump on the measurement screen. Or used to reset an alarm in an alarm state. In the display/setting mode, press this button to decrease a numeric value.
(9) PEAK/ESC button	Used to switch the mode or display.
(10) POWER/ENTER button	Used to turn ON/OFF the power.
(11) Gas outlet (GAS OUT)	Exhausts the gas drawn into the gas monitor. (Do not block it.)
(12) Gas inlet (GAS IN)	Draws a gas into the gas monitor. Connects the accessory tube, etc.
(13) Charging indicator lamp	Lights up in red during charging and goes off when charging is completed.
(14) Charging jack cover	Removed to connect an AC adapter and charge the batteries.
(15) Buzzer sound opening	Emits a buzzer sound at an alarm. (Do not block it.)
(16) Battery unit screws	Turn these screws to detach and replace the battery unit.



## CAUTION

- Do not jab the buzzer opening with a sharp-pointed item. The unit may malfunction or get damaged, allowing water or foreign matter, etc. to get inside.
- Do not remove the panel sheet on the surface. The water-proof and dust-proof performances will be deteriorated.
- Do not affix a label or the like on the infrared port. Infrared communications can no longer be conducted.

**<Display>**

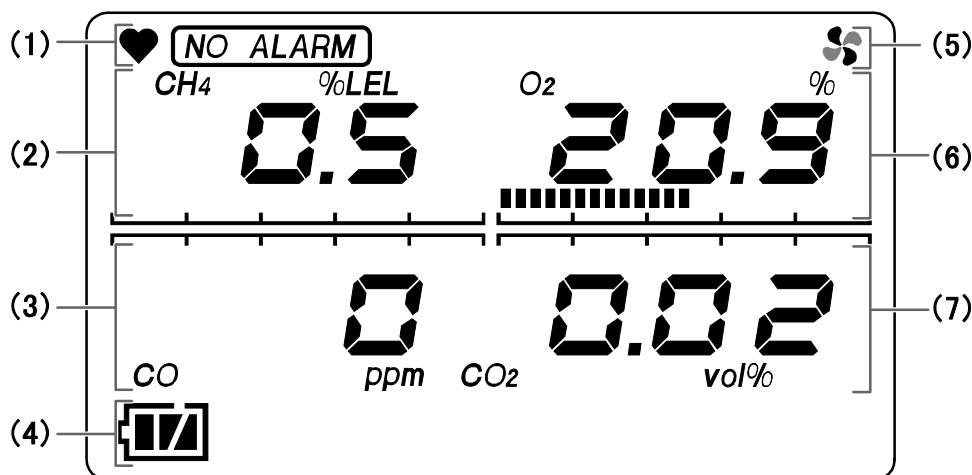

Item	Main function
(1) <b>Operating status display</b>	Displays the operating status in the measuring mode. A heart symbol blinks in the normal state.
(2) <b>Combustible gas concentration display Digital and bar display</b>	Displays the gas concentration as a numeric value and a level in the bar graph.
(3) <b>Carbon monoxide concentration display Digital and bar display</b>	Displays the gas concentration as a numeric value and a level in the bar graph.
(4) <b>Battery level icon</b>	Displays the battery level. See NOTE for a guide for battery level.
(5) <b>Pump driving indicator</b>	Displays the drawing status in the measuring mode. Rotates at a normal state.
(6) <b>Oxygen concentration display Digital and bar display</b>	Displays the gas concentration as a numeric value and a level in the bar graph.
(7) <b>Carbon dioxide concentration display Digital and bar display</b>	Displays the gas concentration as a numeric value and a level in the bar graph.

**NOTE**

- The meanings of battery level icons are as follows:  
: Sufficient/ : Low/ : Needs charging  
 If the battery level further drops, the inside of the battery icon starts to blink ( ).
- The gas alarm function is an optional setting.
- When "NO ALARM" lights up, no gas alarm pattern is performed.

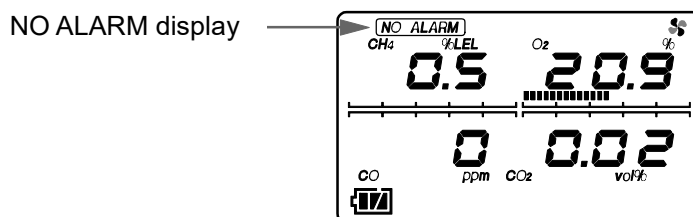

## <RX-8700 (with lithium ion battery unit BUL-8000)>

### <Main Unit>

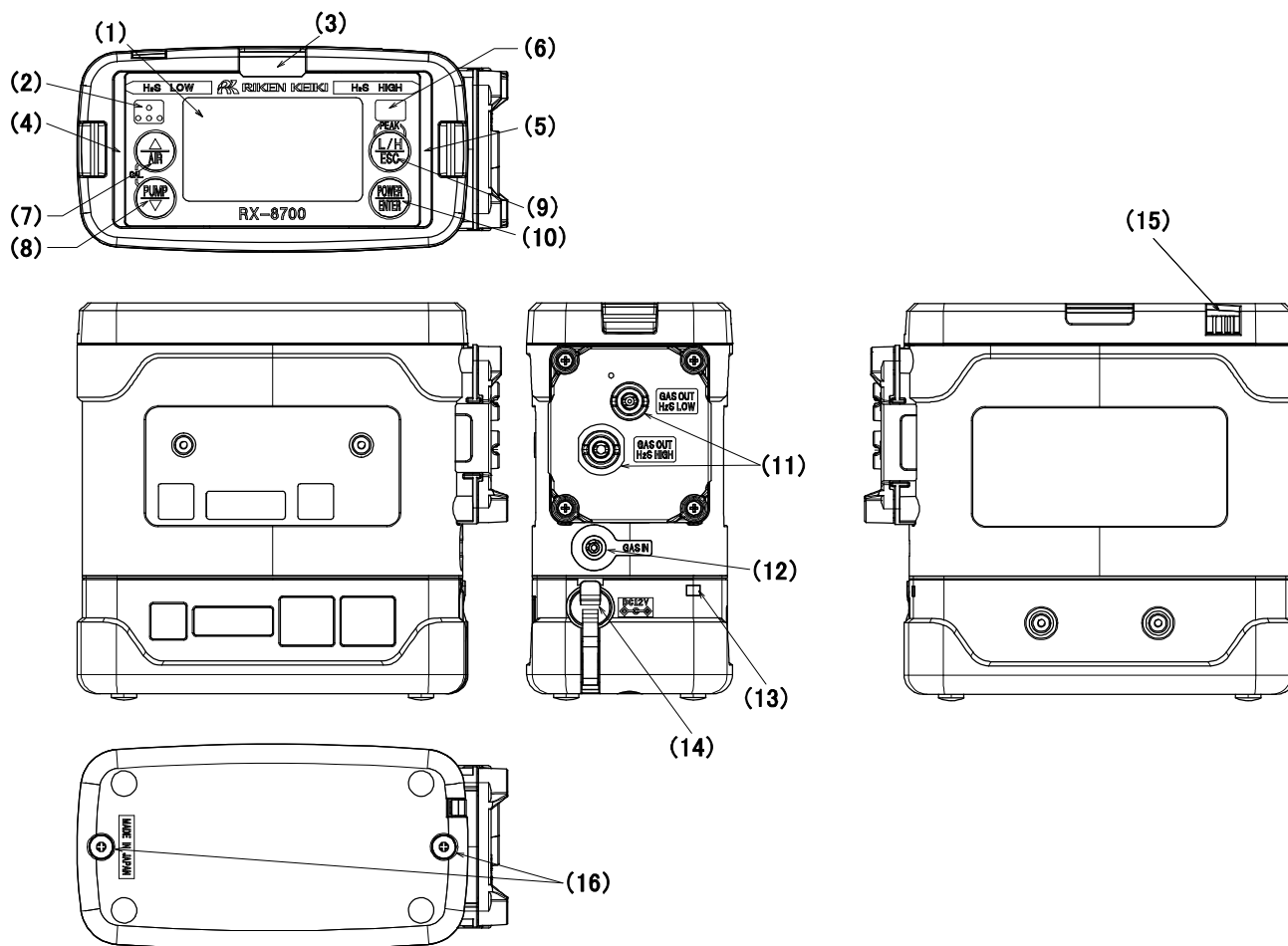

Name	Main function
(1) LCD display	Displays a gas concentration, alarm, etc.
(2) Buzzer sound opening	Emits a buzzer sound at an alarm. (Do not block it.)
(3) Alarm LED arrays	The red lamp blinks in response to an alarm.
(4) HC/O <sub>2</sub> /H <sub>2</sub> S [low concentration] measuring mode indicator lamp	Lights up (in green) when HC/O <sub>2</sub> /H <sub>2</sub> S [low concentration] measuring mode is entered.
(5) H <sub>2</sub> S [high concentration] measuring mode indicator lamp	Lights up (in green) when H <sub>2</sub> S [high concentration] measuring mode is entered.
(6) Infrared communication port	Used to carry out data communications with a PC when the data logger management program is used.
(7) ▲/AIR button	Used to perform air calibration on the measurement screen. Or used to increase a numeric value in the display/setting mode.

Name	Main function
(8) ▼/PUMP button	Used to turn ON/OFF the pump on the measurement screen. Or used to reset an alarm in an alarm state. In the display/setting mode, press this button to decrease a numeric value.
(9) PEAK/L/H/ESC button	Used to switch the mode between the H2S [high concentration] measuring mode and HC/O2/H2S [low concentration] measuring mode on the measurement screen. Or used to switch the mode or display in the display/setting mode.
(10) POWER/ENTER button	Used to turn ON/OFF the power.
(11) Gas outlet (GAS OUT)	Exhausts the gas drawn into the gas monitor. (Do not block it.)
(12) Gas inlet (GAS IN)	Draws a gas into the gas monitor. Connects the accessory tube, etc.
(13) Charging indicator lamp	Lights up in red during charging and goes off when charging is completed.
(14) Charging jack cover	Removed to connect an AC adapter and charge the batteries.
(15) Buzzer sound opening	Emits a buzzer sound at an alarm. (Do not block it.)
(16) Battery unit screws	Turn these screws to detach and replace the battery unit.



### CAUTION

- Do not jab the buzzer opening with a sharp-pointed item. The unit may malfunction or get damaged, allowing water or foreign matter, etc. to get inside.
- Do not remove the panel sheet on the surface. The water-proof and dust-proof performances will be deteriorated.
- Do not affix a label or the like on the infrared port. Infrared communications can no longer be conducted.

**<Display (HC/O<sub>2</sub>/H<sub>2</sub>S [low concentration] measuring mode)>**

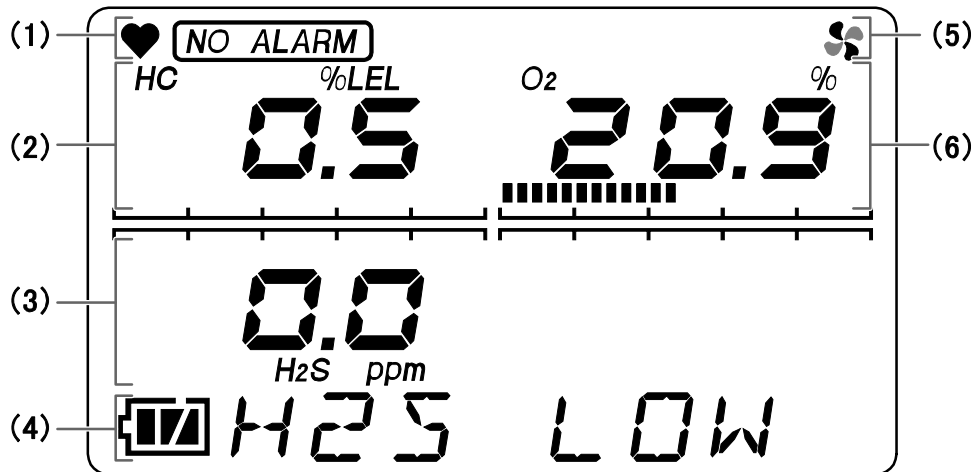

Item	Main function
(1) <b>Operating status display</b>	Displays the operating status in the measuring mode. A heart symbol blinks in the normal state.
(2) <b>Combustible gas concentration display Digital and bar display</b>	Displays the gas concentration as a numeric value and a level in the bar graph. (HC concentration is displayed after isobutane conversion.)
(3) <b>Hydrogen sulfide [low concentration] concentration display Digital and bar display</b>	Displays the gas concentration as a numeric value and a level in the bar graph.
(4) <b>Battery level icon</b>	Displays the battery level. See NOTE for a guide for battery level.
(5) <b>Pump driving indicator</b>	Displays the drawing status in the measuring mode. Rotates at a normal state.
(6) <b>Oxygen concentration display Digital and bar display</b>	Displays the gas concentration as a numeric value and a level in the bar graph.

**<Display (H2S [high concentration] measuring mode)>**

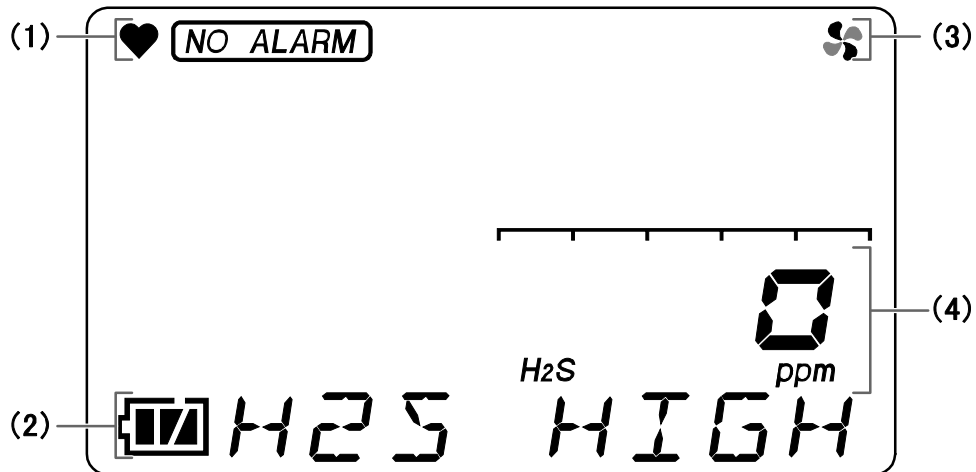

Item	Main function
(1) <b>Operating status display</b>	Displays the operating status in the measuring mode. A heart symbol blinks in the normal state.
(2) <b>Battery level icon</b>	Displays the battery level. See NOTE for a guide for battery level.
(3) <b>Pump driving indicator</b>	Displays the drawing status in the measuring mode. Rotates at a normal state.
(4) <b>Hydrogen sulfide [high concentration] concentration display Digital and bar display</b>	Displays the gas concentration as a numeric value and a level in the bar graph.

**NOTE**

- The meanings of battery level icons are as follows:  
: Sufficient/ : Low/ : Needs charging  
 If the battery level further drops, the inside of the battery icon starts to blink ( ).
- The gas alarm function is an optional setting.
- When "NO ALARM" lights up, no gas alarm pattern is performed.

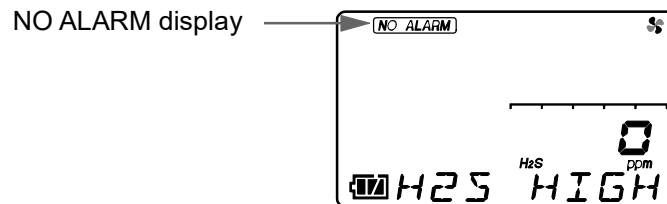

---

## 4

---

# How to Use

### 4-1. Before using the gas monitor

Not only the first-time users but also the users who have already used the gas monitor must follow the operating precautions.

Ignoring the precautions may damage the unit, resulting in inaccurate gas measurement.

### 4-2. Preparation for start-up

Before starting gas measurement, check the followings.

- Check that the battery level is sufficient.
- Check that the filter inside the gas monitor is not contaminated or clogged.
- Check that there is no bend or hole in the gas sampling hose and relay tube.
- Check that the main unit, relay tube, filter tube, gas sampling hose and gas sampling probe are connected properly in this order.



#### **DANGER**

- Perform charging of the lithium ion battery unit or replacement of the battery unit/dry batteries in a safe place.

### 4-2-1. Charging the lithium ion battery unit (BUL-8000(Z1))

When the gas monitor is used for the first time, or when the battery level is low, be sure to use the dedicated AC adapter to charge the battery unit.

- 1 Open the charging jack cover of the lithium ion battery unit.**
- 2 Insert the AC adapter plug into the charging jack.**

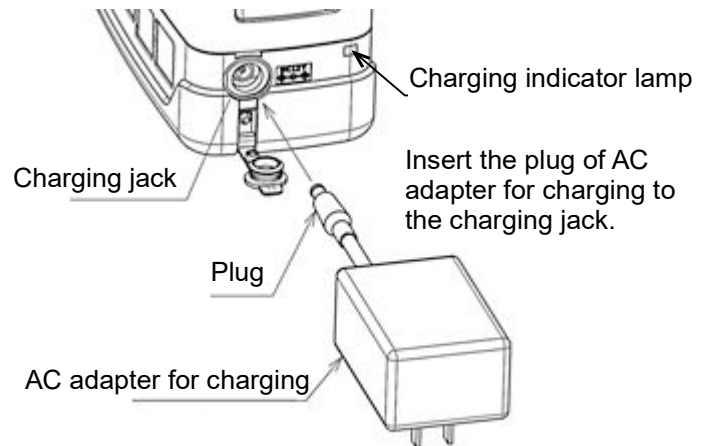

- 3 Insert the AC adapter to the outlet.**

When charging is started, the charging indicator lamp lights up in red.

(Charging time: Three hours at the maximum until the battery unit is fully charged)

When charging is completed, the charging indicator lamp goes off.

- 4 When charging is completed, disconnect the AC adapter from the outlet.**
- 5 Disconnect the AC adapter plug from the charging jack and attach the charging jack cover.**

Push the charging jack cover as far as it will go.



#### **DANGER**

- Charge the battery unit using the dedicated AC adapter in a safe place.
- Charge the battery unit at ambient temperatures between 0 to 40°C.
- Do not use the gas monitor while charging it. Correct measurements cannot be obtained. Furthermore, the batteries get deteriorated more quickly and may have shorter life.
- The charger is neither water-proof nor dust-proof. Do not charge the batteries while the gas monitor is wet.
- The charger is not explosion-proof.



## CAUTION

- Do not pull the charging jack cover hard to open the cover in the step 1. It may get damaged.
- Do not use the battery unit with the charging jack cover detached. Dust or water may get into the gas monitor, causing it to malfunction. If the charging jack cover is damaged, replace the battery unit with new one.
- If the charging jack cover is not completely closed, water may get in from the charging jack. The same thing may occur if a minute foreign substance gets stuck between the cover and the unit.
- Disconnect the AC adapter from the outlet while it is not in use.

## NOTE

- During charging, the lithium ion battery unit may get hot, but this is not an abnormality.
- The temperature of the unit is high immediately after charging is completed. Let it stand for 10 minutes or more before using it. Using the lithium ion battery unit while it is still hot may cause erroneous measurement.
- When a fully charged battery unit is recharged, the charging indicator lamp does not light up.

## 4-2-2. Detaching and attaching the battery unit

- 1 Loosen the two battery unit screws on the bottom.**

<Lithium ion battery>

Battery unit screws

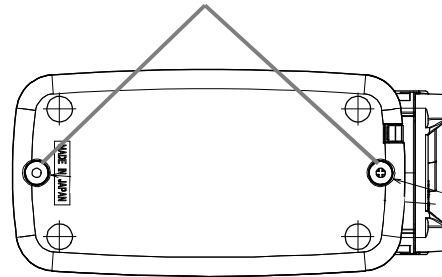

<Dry battery unit (option)>

Battery unit screws

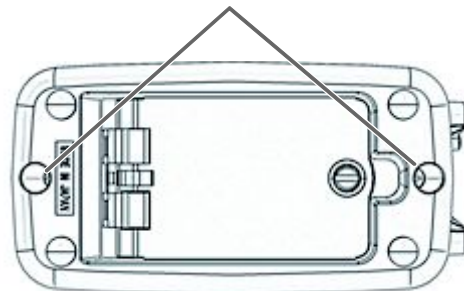

- 2 Detach the battery unit.**

**3 Attach a new battery unit and then tighten the two battery unit screws.**

Attach the battery unit in the correct direction with attention to the connection terminal or projections.

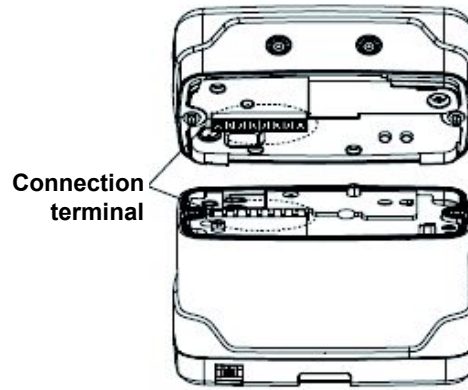

**CAUTION**

- Turn off the power of the gas monitor before replacing the battery unit.
- Replace the battery unit in a safe place.
- If the battery unit screws are not tightened securely, the battery unit may drop off or water may get in through the clearance. Water may also get in if a minute foreign substance is caught between the battery unit and gas monitor.
- Do not damage the rubber seal. To maintain the water-proof and dust-proof performances, it is recommended to replace the rubber seal every two years, whether or not it has an abnormality.

**4-2-3. Attaching batteries to the dry battery unit (BUD-8000(Z), option)**

When the gas monitor is used for the first time, or when the battery level is low, attach new AA alkaline batteries.

**1 Open the battery cover located at the bottom of the dry battery unit using a flathead screwdriver or coin.**

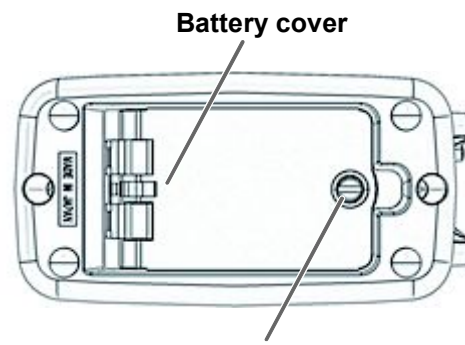

**2 Attach three new dry batteries observing the correct polarity.**

Remove old batteries as needed.

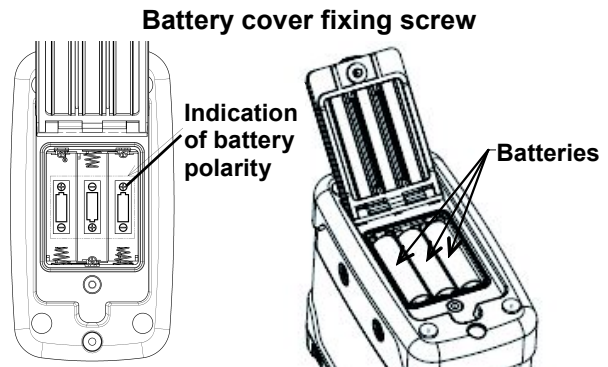

### 3 Close the battery cover and tighten the battery cover fixing screw.



#### DANGER

- The explosion-proof standard for the gas monitor requires the use of TOSHIBA dry batteries. Use three AA alkaline batteries (LR6) produced by TOSHIBA CORPORATION to use the gas monitor as an explosion-proof unit.



#### CAUTION

##### Replacement of batteries

- Turn off the power of the gas monitor before replacing the dry batteries.
- Replace the dry batteries in a safe place.
- Pay attention to the polarities of the dry batteries.
- If the battery cover fixing screw is not tightened securely, the dry batteries may drop off or water may get in through the clearance. Water may also get in if a minute foreign substance is caught between the cover and the unit.

##### Batteries

- Replace all of the three batteries with new ones.
- Rechargeable batteries cannot be used.

## 4-2-4. Connecting the gas sampling probe and gas sampling hoses

Attach the gas sampling hose to the gas sampling probe.

Connect the relay tube, filter tube, gas sampling hose and gas sampling probe in this order securely to the gas inlet (GAS IN) of the main unit.

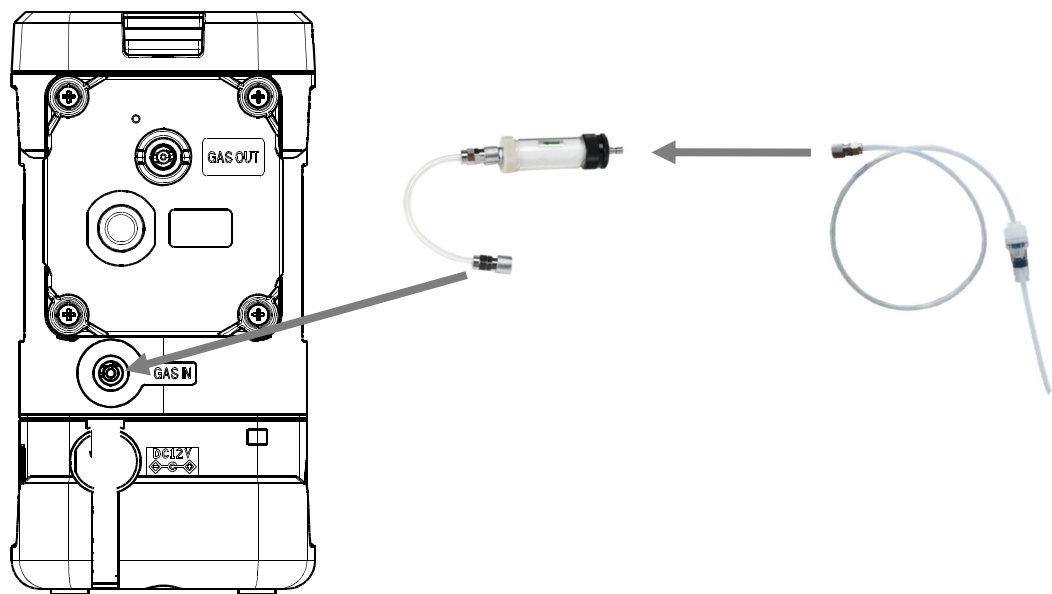

**CAUTION**

- Use only a gas sampling hose specified by RIKEN KEIKI.
- The gas sampling hose must be connected to the gas sampling probe before use so that no foreign substance is drawn into it.
- Be sure to connect the gas sampling probe and gas sampling hose by fastening them by hand. Fastening them too tight using a tool may break the plastic part of the gas sampling probe.

**NOTE**

- When connecting a part to the gas inlet (GAS IN), push the part until it clicks into place.

# 4-3. How to start the gas monitor

When the power is turned on, self-diagnosis starts and then the measurement screen appears.

## 4-3-1. Power-on

Hold down the **POWER/ENTER** button (over three seconds) until the buzzer blips to turn on the power. When the power is turned on, the LCD display changes automatically as shown below before the measurement screen is displayed.

- Hold down the **POWER/ENTER** button for at least 3 seconds.**



Hold down the button until the entire LCD display and alarm lamp light up and the buzzer blips.

All LCDs light up



Gas name display

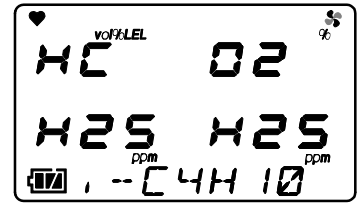
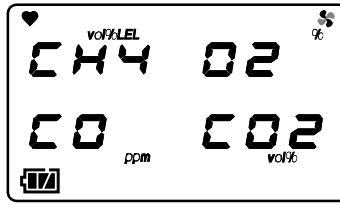

Full scale display

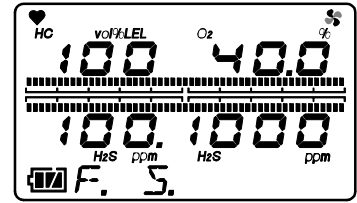
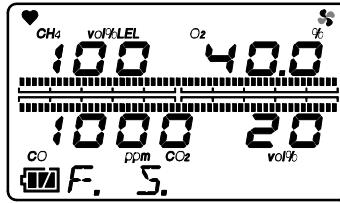

ID display



The screens on the right are displayed alternately until the **ENTER** button is pressed.

Filter connection check

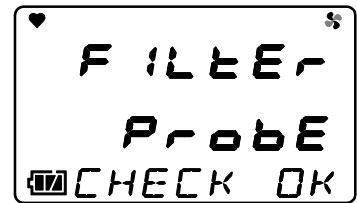

**2 Press the **ENTER** button.**

The sensor warm-up operation is performed for about 25 seconds.



The buzzer blips twice and then the measurement screen is displayed.

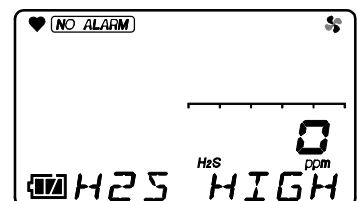
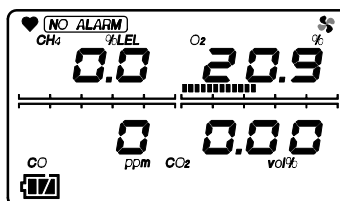





**CAUTION**

- After start-up, perform air calibration (P. 37) before performing gas measurement.
- RX-8700 is started in the H2S [high concentration] measuring mode.

**NOTE**

- If any abnormality is detected in the sensor, a sensor abnormality alarm is triggered just before entering the measuring mode. Press the  button when a sensor abnormality alarm is triggered. The sensor abnormality alarm is reset temporarily, and "- - -" appears in the concentration display area of the gas with sensor abnormality before starting measurement (the alarm cannot be reset if all sensors have an abnormality). In this case, promptly contact RIKEN KEIKI. Gas measurement cannot be performed with a sensor having an abnormality.
- If there is an abnormality in the built-in clock, a fault alarm "FAIL CLOCK" may be triggered. Press the  button when the alarm is triggered. The fault alarm is temporarily reset, and measurement is started with incorrect clock time.

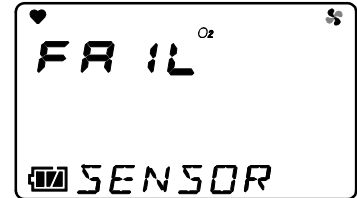

Display example  
(Oxygen sensor abnormality)

**4-3-2. Switching the hydrogen sulfide measuring mode range on RX-8700**

RX-8700 switches the mode between the H2S [high concentration] measuring mode and HC/O2/H2S [low concentration] measuring mode.

**Hold down the  button (about one second) and release it when the buzzer blips once.**

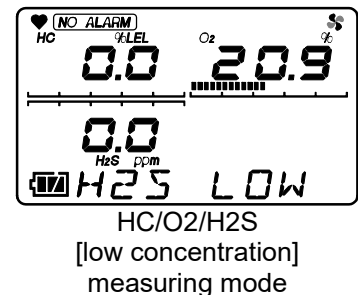
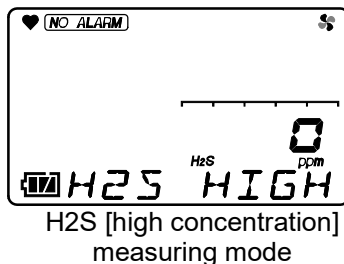

# 4-4. Basic operating procedures

This mode is used on the measurement screen after power-on.

## 4-4-1. RX-8500 basic operating procedures

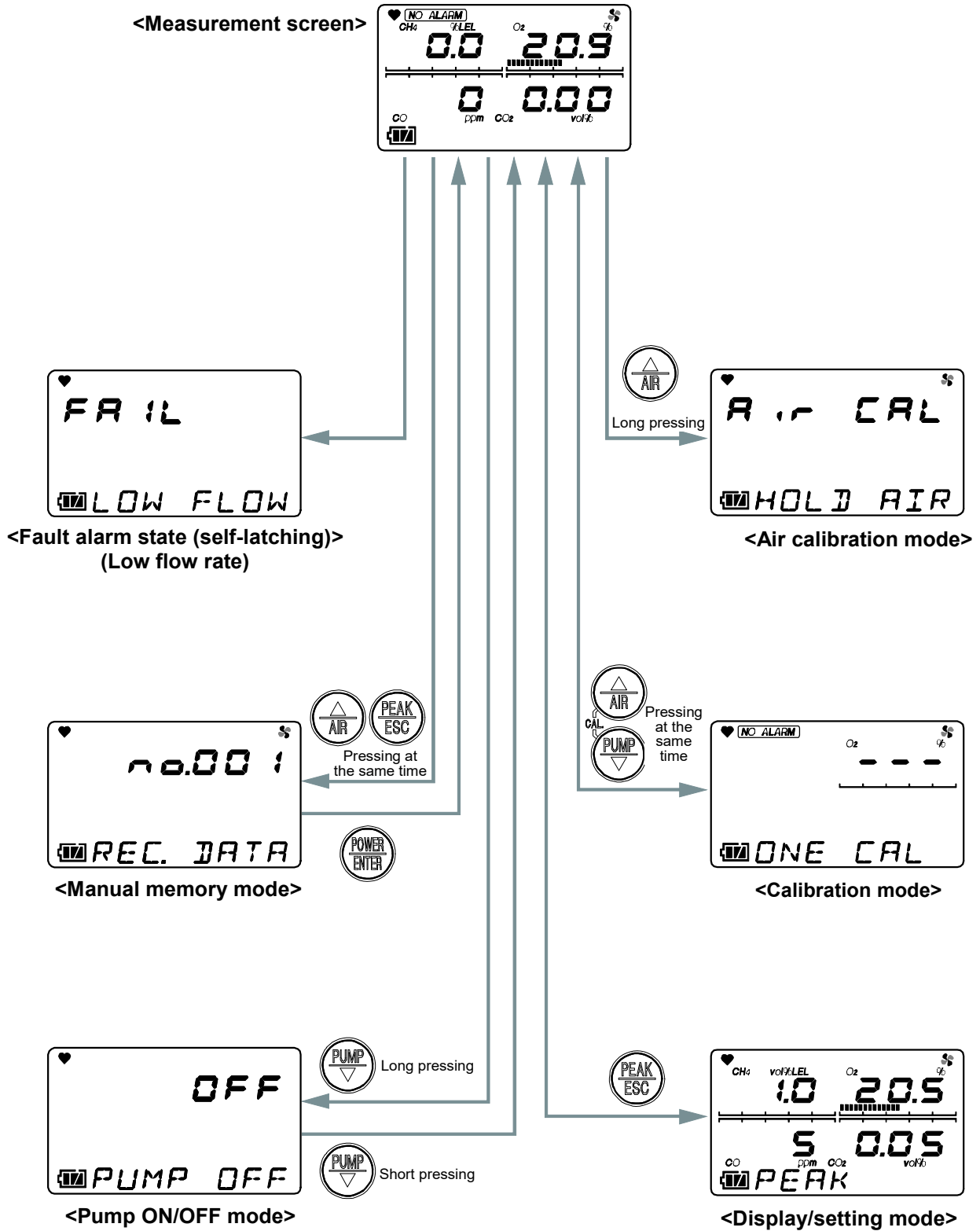

### 4-4-2. RX-8700 basic operating procedures

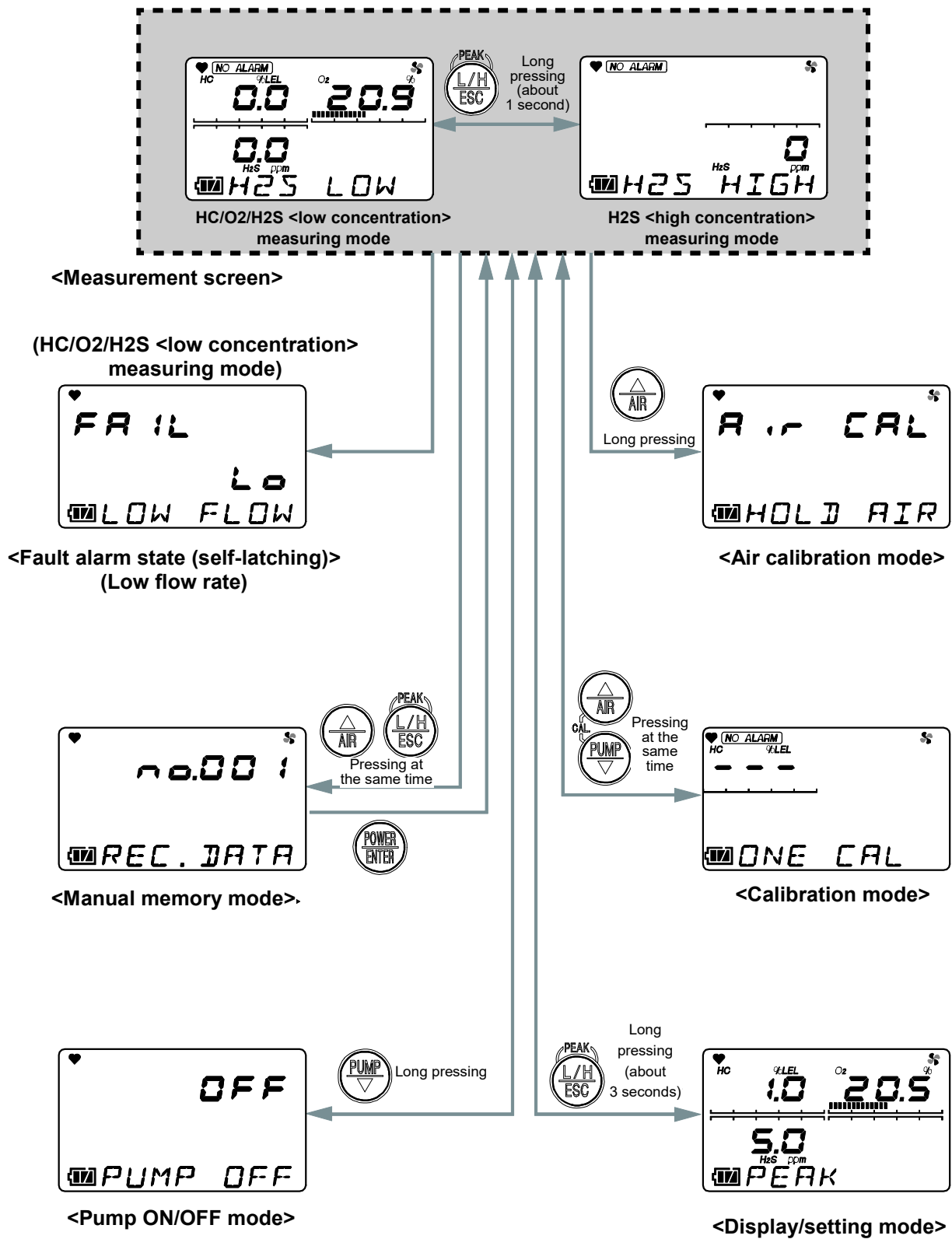

## 4-5. Measurement

Measure gas concentration on the measurement screen. Put the gas sampling probe close to the measurement area.

Once gas concentration measurement is started, the gas monitor draws in a measuring gas for a certain period of time and then displays a concentration value as a measurement result.

### 4-5-1. Gas concentration measurement

With the measurement screen displayed, put the gas sampling probe close to the measurement area and take the reading on the LCD display.

#### <RX-8500>

Combustible gas concentration  
(CH<sub>4</sub>: Methane)  
: 0.0% LEL, 0 vol%

Carbon dioxide concentration  
: 0 ppm

Battery level  
: Sufficient

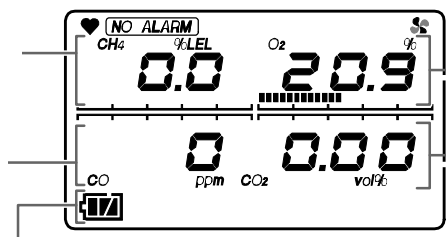

Oxygen concentration  
: 20.9%

Carbon dioxide concentration  
: 0.00 vol%

#### <RX-8700>

H<sub>2</sub>S [high concentration]  
measuring mode

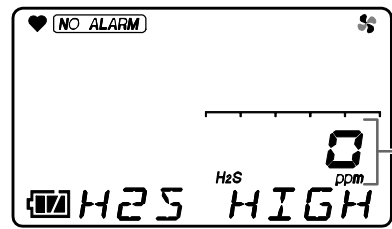

Hydrogen sulfide concentration  
: 0 ppm

HC/O<sub>2</sub>/H<sub>2</sub>S [low concentration]  
measuring mode

Combustible gas concentration  
(HC: Isobutane converted)  
: 0.0% LEL, 0 vol%

Hydrogen sulfide concentration  
: 0.0 ppm

Battery level  
: Sufficient

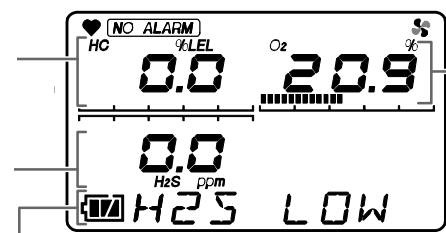

Oxygen concentration  
: 20.9%

**WARNING**

- The gas monitor is designed to draw gases around it under the atmospheric pressure. If excessive pressure is applied to the gas inlet (GAS IN) and outlet (GAS OUT) of the gas monitor, measured gases may leak out from its inside and may cause dangerous conditions. Be sure that excessive pressure is not applied to them while used.
- Do not connect the sampling hose directly to a measurement area with a pressure higher than the atmospheric pressure. The internal piping system may be damaged.
- When air calibration is performed in the atmosphere, check the atmosphere for freshness before beginning it. If interference gases exist, the calibration cannot be performed properly, thus leading to dangers when the gas leaks.
- Issuance of a gas alarm indicates that there are extreme dangers. Take proper actions based on your judgment.
- Before use, check that there remains sufficient battery power. When the gas monitor is used for the first time or is not used for a long period, the batteries may be exhausted. Either fully charge the batteries or replace them with new ones before use.
- Gas measurement cannot be performed with a low battery voltage. If the low battery voltage alarm is triggered during use, turn off the power and promptly charge or replace the batteries in a safe place.
- Do not block the buzzer sound opening. No alarm sound can be heard.

**CAUTION**

- Before performing gas measurement, connect the gas sampling probe provided with the gas monitor to prevent disturbances by air dust.
- When measuring concentrations of oxygen in inert gases for a long time, the carbon dioxide concentration in the air must be 15% or less. When the gas monitor is used in the inert gas with a carbon dioxide concentration higher than 15%, perform measurement in as short time as possible.
- Do not use the gas monitor in a place with high oxygen concentration for a long time. The oxygen sensor life may be shortened.

**NOTE**

- In a low-temperature environment, the operating time is shortened due to the battery performance property.
- At low temperatures, the responses of the LCD display may slow down.
- If a combustible gas with 100% LEL or higher concentration is drawn, adsorbed gases may remain in the gas sampling hose or gas sampling probe. After drawing a high-concentration combustible gas, be sure to draw fresh air and perform air cleaning until the reading nears zero to remove adsorbed gases. Performing air calibration before cleaning completely may result in inaccurate air calibration, giving adverse influence on measurement. In such a case, remove the gas sampling probe and hose and then perform air calibration to avoid inaccurate calibration.
- [RX-8700] To measure an area where high-concentration hydrogen sulfide may be present, use the H2S [high concentration] measuring mode.
- [RX-8700] To measure hydrogen sulfide concentration, check that hydrogen sulfide concentration is less than 100 ppm in the H2S [high concentration] measuring mode and then measure combustible gas and oxygen concentrations in the HC/O2/H2S [low concentration] measuring mode. Drawing high-concentration hydrogen sulfide in the HC/O2/H2S [low concentration] measuring mode may damage the combustible gas, oxygen or low-concentration hydrogen sulfide sensor.

## 4-5-2. Range switching point

The display automatically switches to the vol% range when the concentration of a measured combustible gas exceeds 100% LEL. When the concentration drops, the display returns to the %LEL range again. The following shows an example of switching timing.

### <Example of gas concentrations and range switching timing>

#### (1) RX-8500

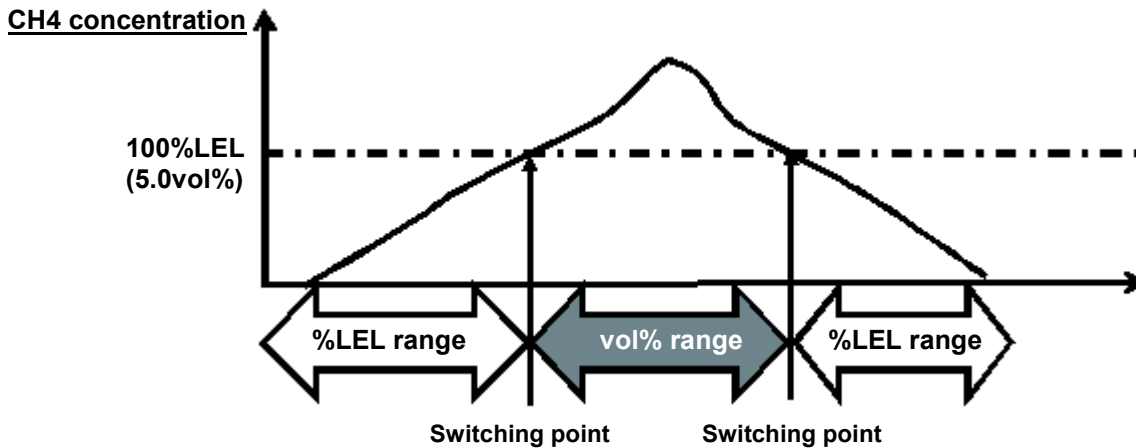

#### Combustible gas concentration display

- CH4: Methane
- The range switching point is a lower explosive limit of a gas. It is 5.0 vol% for methane.

#### (2) RX-8700

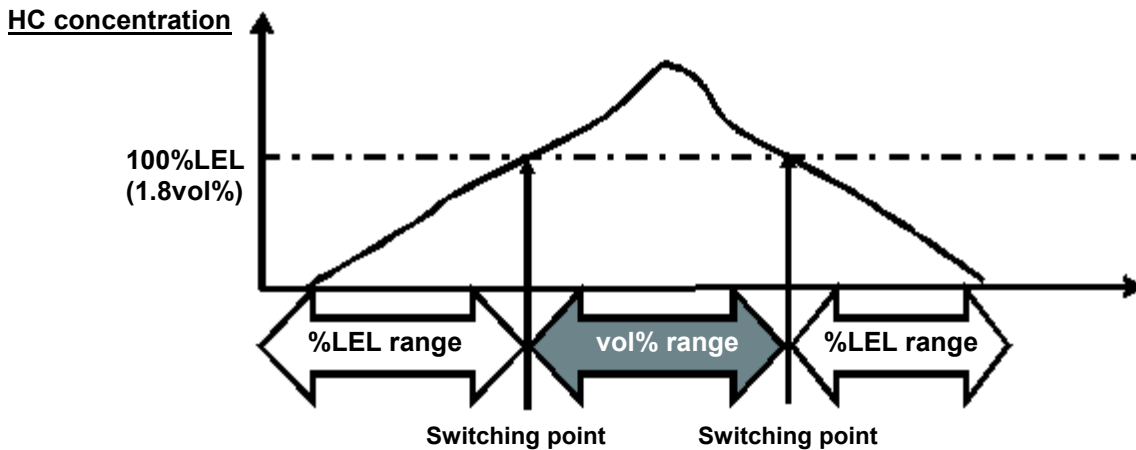

#### Combustible gas concentration display

- HC: Isobutane converted
- The range switching point is a lower explosive limit of a gas. It is 1.8 vol% for isobutane.

## 4-6. Air calibration

Air calibration is zero adjustment to correctly measure the current gas concentration.

### 4-6-1. Attaching the CO2 removal filter (RX-8500)

To perform zero calibration for carbon dioxide (CO<sub>2</sub>), CO<sub>2</sub> in the air needs to be removed using the CO<sub>2</sub> removal filter.

Attach the CO<sub>2</sub> removal filter so that the arrow (->) on the side is directed at the filter tube.

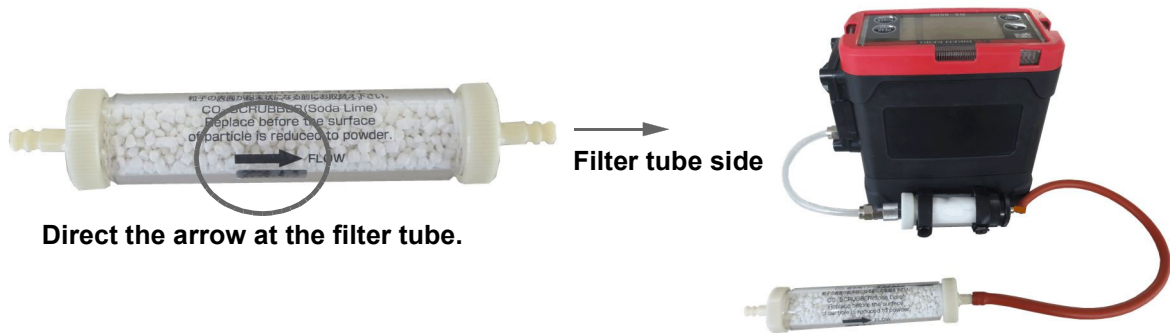

Stand the CO<sub>2</sub> removal filter to use. With it laid horizontally, CO<sub>2</sub> in the air may not be absorbed.

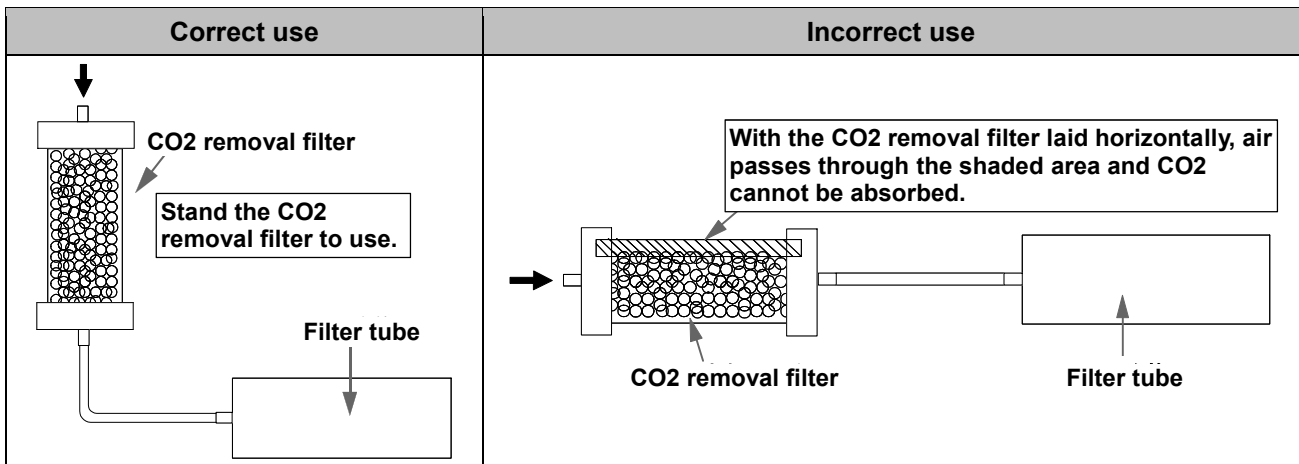

The number of usable times per filter depends on the carbon dioxide concentration in the air. It varies also by the air tightness of CO<sub>2</sub> removal filter, storage temperature or humidity.

The following table shows guide values assuming that each use takes one minute for drawing. However, use the removal filter with a margin when the carbon dioxide concentration in the environment is unknown.

Measurement environment carbon dioxide (CO <sub>2</sub> ) concentration	Estimated number of usable times in consideration of storage condition
500ppm	Approx. 1000 times
1000ppm	Approx. 500 times
2000ppm	Approx. 200 times
4000ppm	Approx. 100 times



**CAUTION**

- Do not draw high-concentration carbon dioxide during zero calibration.
- Do not breathe on the inlet during zero calibration.
- Block ventilation to the air after using the CO2 removal filter. With the air mixed, the absorbent absorbs carbon dioxide in the air, resulting in degraded absorption performance.
- Store the CO2 removal filter in a dry place away from direct sunlight.

**NOTE**

- The number of usable times per filter depends on the carbon dioxide concentration in the air. It varies also by the air tightness of CO2 removal filter, storage temperature or humidity.
- The above table shows guide values assuming that each use takes one minute for drawing. However, use the removal filter with a margin when the carbon dioxide concentration in the environment is unknown.

**4-6-2. Air calibration procedure**

**1 Hold down the AIR button on the measurement screen.**

The air calibration screen is displayed.

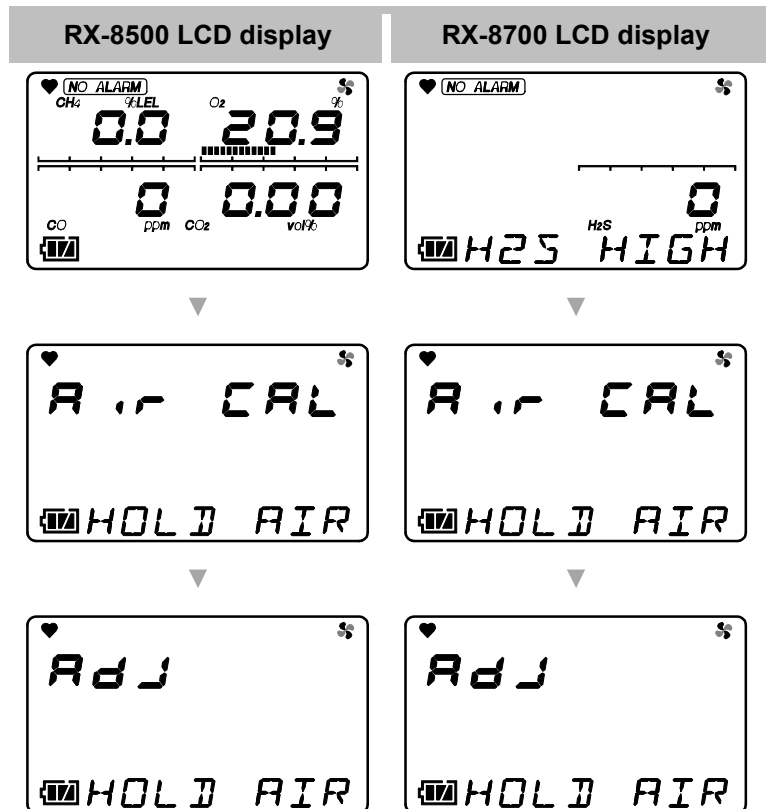

Keep the AIR button pressed while the screen shown in the right figure is displayed.  
Air calibration is not started if the button is released before the screen is displayed.

Press the ESC button to stop air calibration.

- 2 Release the **AIR** button when the screen shown in the right figure is displayed.**

On RX-8500, nitrogen gas calibration is performed next. Pressing the **ESC** button skips nitrogen gas calibration and performs air calibration. On RX-8700, nitrogen gas calibration is not performed.



- 3 For RX-8500, attach the CO2 removal filter and press the **ENTER** button.**

See "4-6-1. Attaching the CO2 removal filter" for how to attach the CO2 removal filter.

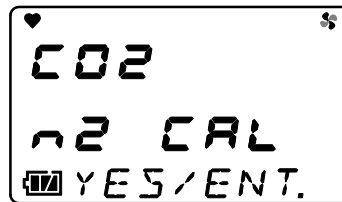

When air calibration is completed, the screen shown in the right figure is displayed.

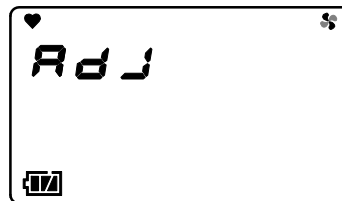

**WARNING**

- When air calibration is performed in the atmosphere, check the atmosphere for freshness before beginning it. If interference gases exist, air calibration cannot be performed, thus leading to dangers when the gas leaks.
- Perform air calibration under pressure and temperature/humidity conditions close to those in the operating environment and in fresh air.
- Perform air calibration after the reading is stabilized.
- If there is a sudden temperature change of 15°C or more between the storage and operational locations, turn on the power of the gas monitor, let it stand for about 10 minutes in a similar environment to the operational location, and perform air calibration in fresh air before using it.
- [RX-8500] The amount of carbon dioxide in the air is about 300 to 500 ppm. If air calibration for the carbon dioxide sensor is performed while directly drawing air where carbon dioxide is present, correct measurement of gas concentration becomes impossible. Before performing air calibration on RX-8500, attach the CO2 removal filter and draw air for at least one minute.

**NOTE**

- If air calibration fails, "FAIL - AIR CAL" is displayed along with the name of gas sensor which has become faulty. Press the  button to reset the fault alarm (calibration failure). When the alarm is reset, the value before calibration is displayed.
- [RX-8500] Do not draw high-concentration carbon dioxide during air calibration.
- [RX-8500] Do not breathe on the inlet (GAS IN) during air calibration.
- [RX-8500] Block ventilation to the air after using the carbon dioxide removal filter. With the air mixed, the absorbent absorbs carbon dioxide in the air, resulting in degraded absorption performance.
- [RX-8700] Perform air calibration in each of the two modes (H2S [high concentration] measuring mode and HC/O2/H2S [low concentration] measuring mode).

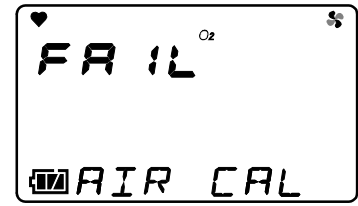

Air calibration failure display example  
Oxygen (O<sub>2</sub>) sensor

## 4-7. Manual memory

Up to 256 arbitrary instantaneous values during measurement can be recorded.

When the number of recorded data points reaches the maximum, recorded data will be overwritten, starting from the oldest data.

### 1 Hold down the **▲** and **PEAK** buttons on the measurement screen.

The memory number, recorded date and recorded concentration are displayed in turn as shown below.

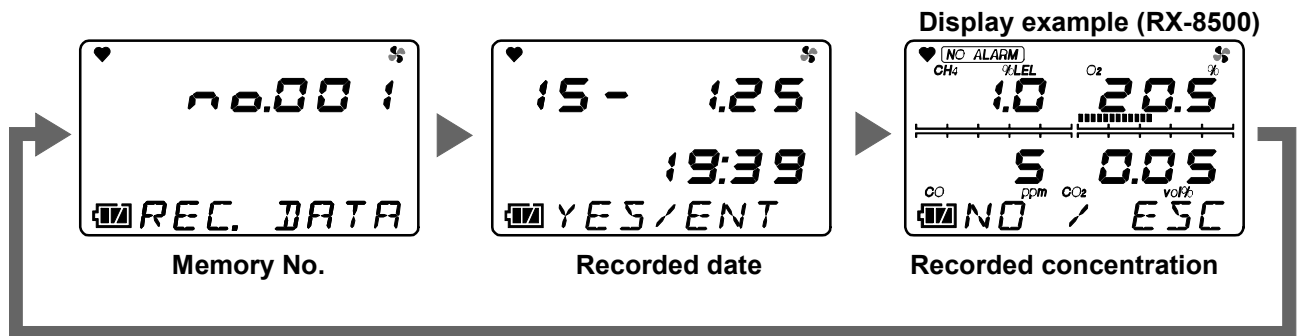

Press the **ESC** button to skip recording the displayed contents. The measurement screen returns.

### 2 Press the **ENTER** button.

"END" is displayed on the screen, and the memory number, date and gas concentration at the time the **ENTER** button is pressed are recorded.

After recording the data, the measurement screen returns automatically.



#### NOTE

- If **PEAK** and **▲** buttons are not pressed at the same time, the air calibration (P. 37) or display/setting (P. 44) screen is displayed. In this case, release both buttons and try again after displaying the measurement screen.

## 4-8. Stopping the pump (PUMP OFF mode)

The pump operation can be stopped.

**1 Hold down the **PUMP** button on the measurement screen (about five seconds).**

The pump stops operating.

The buzzer blips twice every three minutes or so while the pump operation is stopped.

**2 Press the **PUMP** button to activate the pump.**

The measurement screen returns.

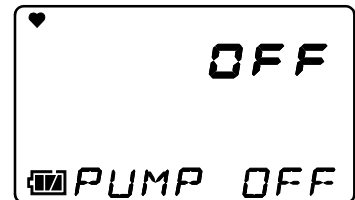

### WARNING

- No alarm is triggered under any circumstances in the PUMP OFF state.
- The measuring mode does not return automatically in the PUMP OFF state.

## 4-9. Power-off



### CAUTION

- If the concentration display is not reset to zero (or 20.9% for the oxygen concentration display) after measurement is completed, leave the gas monitor in fresh air until the display returns to zero and then turn off the power.

### Keep the **POWER/ENTER** button pressed.

To turn off the power, hold down the **POWER/ENTER** button after the display returns to zero (0, or 20.9% for oxygen) in a safe place.

The buzzer blips three times and "TURN OFF" appears on the display before the power is turned off.

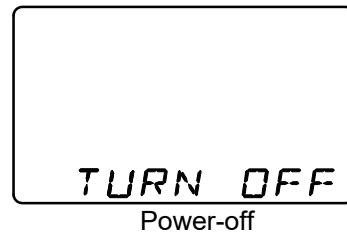
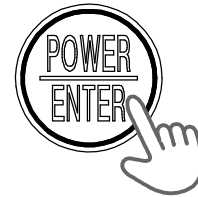

### NOTE

- To turn off the power, keep the button pressed until the display disappears.
- If the display is not zero when the power is turned off, a purge operation may be performed for 30 seconds at the maximum on RX-8500 or 60 seconds at the maximum on RX-8700 to clean the inside of the gas monitor.



<RX-8500>



<RX-8700>



A purge operation is performed in the H<sub>2</sub>S [high concentration] measuring mode (HI) and then the HC/O<sub>2</sub>/H<sub>2</sub>S [low concentration] measuring mode (LO).

## 5

# Setting Procedure

## 5-1. Display/setting mode

This mode allows users to display or change various settings.

### RX-8500

#### 1 Press the **PEAK** button on the measurement screen.

The following display/setting screens are displayed in turn by pressing the **PEAK** button.

- Press **PEAK** once: PEAK display/clear
- Press **PEAK** twice: Alarm setpoint display
- Press **PEAK** three times: Clock display
- Press **PEAK** four times: Station ID display
- Press **PEAK** five times: Log data display
- Press **PEAK** six times: Return to the measurement screen

### RX-8700

#### 1 Hold down the **PEAK** button on the measurement screen (about three seconds).

#### 2 Release the button when the buzzer blips twice.

- Hold down **PEAK**: PEAK display/clear





#### 3 Press the **PEAK** button again.

The following display/setting screens are displayed in turn by pressing the **PEAK** button.

- Hold down **PEAK** and then press it once: Alarm setpoint display
- Hold down **PEAK** and then press it twice: Clock display
- Hold down **PEAK** and then press it three times: Station ID display
- Hold down **PEAK** and then press it four times: Log data display
- Hold down **PEAK** and then press it five times: Return to the measurement screen

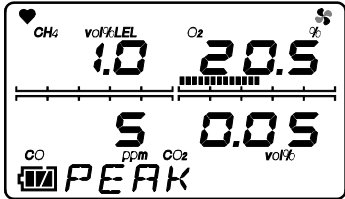
### NOTE

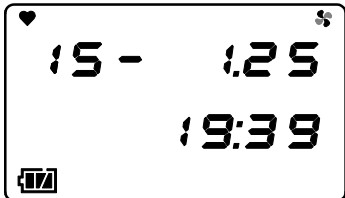
- When the unoperated period lasts about 20 seconds, the measurement screen returns automatically.
- [RX-8700] When the button is released after the buzzer blips once in the step 2, it causes a switch between the H<sub>2</sub>S [high concentration] measuring mode and HC/O<sub>2</sub>/H<sub>2</sub>S [low concentration] measuring mode and fails to enter the display/setting mode.
- [RX-8700] The display/setting mode can be entered from either of the two modes (H<sub>2</sub>S [high concentration] measuring mode and HC/O<sub>2</sub>/H<sub>2</sub>S [low concentration] measuring mode).

Item	Details	LCD display	Remarks
<b>PEAK display/clear</b>	Displays the maximum concentration (or minimum concentration for oxygen) obtained during measurement from power-on to the present. Clears a peak value as well.	<b>PEAK display on RX-8500</b> 	Go to the display/clear screen (P. 46)
<b>Alarm setpoint display</b> (Full scale/alarm setpoint display/gas alarm test)	Displays the full scale value and first and second alarm setpoints, and allows users to check alarm activation. * The gas alarm function is an optional function.		Press the <b>ENTER</b> button to go to the display screen (P. 47)
<b>Clock display</b>	Displays the current date and time.		
<b>Station ID display</b>	Displays station IDs registered in advance. ID selection is also available.		Press the <b>ENTER</b> button to go to the display/selection screen (P. 48)
<b>Log data display</b>	Displays data recorded in the manual memory.		Press the <b>ENTER</b> button to go to the display screen (P. 49)

## 5-2. PEAK display/clear

This item displays or clears the maximum concentration (or minimum concentration for oxygen) obtained during measurement from power-on to the present.

- 1 Display the screen shown in the right figure on each model.**

### RX-8500

Press the **PEAK** button once on the measurement screen.

### RX-8700

Hold down the **PEAK** button on the measurement screen (about three seconds).

PEAK display on RX-8500

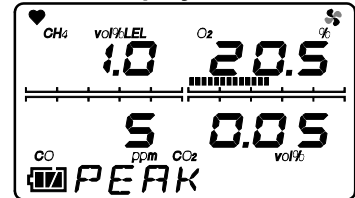

- 2 Hold down the **▼** button to clear PEAK value.**

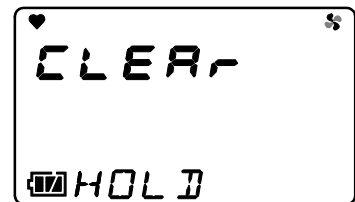

- 3 Release the **▼** button when "RELEASE" is displayed.**

PEAK value has been cleared.

After clearing the value, the buzzer blips and the screen in the step 1 returns.



### NOTE

- When the unoperated period lasts about 20 seconds, the screen in the step 1 is replaced with the measurement screen.

## 5-3. Full scale/alarm setpoint display/gas alarm test (optional function)

This item displays the full scale value and first and second alarm setpoints, and allows users to check alarm activation.

Normally the gas alarm function is set to OFF and unavailable (optional function). To use this function, please contact RIKEN KEIKI.

### 1 Display the screen shown in the right figure on each model.

"ALARM-P" and "YES/ENT" are displayed alternately in the lower part of the screen.

#### RX-8500

Press the **PEAK** button twice on the measurement screen.

#### RX-8700

- Hold down the **PEAK** button on the measurement screen (about three seconds).
- Press the **PEAK** button once.

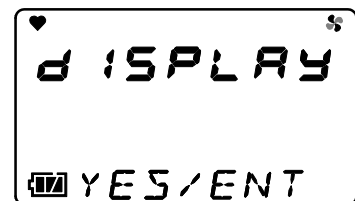

### 2 Press the **ENTER** button.

### 3 Press the **▲/▼** button to display the full scale or first/second alarm setpoint value.

Display example of the case without alarm setpoints on RX-8500

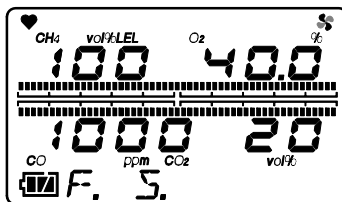

Full scale value

The OVER alarm (over scale) activation occurs in an alarm test.

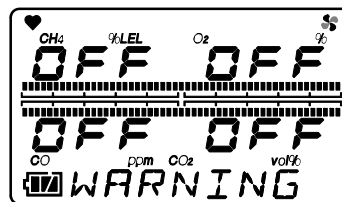

First alarm setpoint

"OFF" appears in the concentration display area.

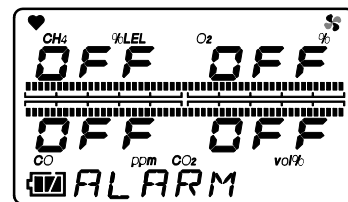

Second alarm setpoint

"OFF" appears in the concentration display area.

### 4 Display a desired screen and press the **ENTER** button.

The alarm LED arrays blink in red, allowing the user to check the alarm activation of the screen displayed.

### 5 Press the **ENTER** or **ESC** button to stop the alarm activation.

Pressing the **ENTER** button stops the alarm activation.

Pressing the **ESC** button stops the alarm activation and then returns to the screen in the step 1.

**NOTE**

- When the unoperated period lasts about 20 seconds, the screen in the step 1 is replaced with the measurement screen.
- No display switch is made during alarm test.

**5-4. Station ID display**

This item displays the registered station IDs and allows users to make a selection.

**1 Display the screen shown in the right figure on each model.****RX-8500**

Press the **PEAK** button four times on the measurement screen.

**RX-8700**

- Hold down the **PEAK** button on the measurement screen (about three seconds).
- Press the **PEAK** button three times.

**2 Press the **ENTER** button.****3 Select station ID with the **▲/▼** button.**

When an ID change is not necessary, press the **ESC** button.

**4 Press the **ENTER** button.**

When the ID display is finished, the buzzer blips and the screen in the step 1 returns.

**NOTE**

- When the unoperated period lasts about 20 seconds, the screen in the step 1 is replaced with the measurement screen.
- When the unit is used for the first time, station ID is displayed as shown in the right figure.
- On the gas monitor, IDs from ST-ID000 to ST-ID127 have been registered, unless otherwise specified.
- The data logger management program (optional) is required to register or change an ID. Please contact RIKEN KEIKI for more information.



## 5-5. Log data display

This item displays the gas concentration data recorded in the manual memory.

### 1 Display the screen shown in the right figure on each model.

#### RX-8500

Press the **PEAK** button four times on the measurement screen.

#### RX-8700

- Hold down the **PEAK** button on the measurement screen (about three seconds).
- Press the **PEAK** button three times.



### 2 Press the **ENTER** button.

### 3 Select log data with the **▲/▼** button and then press the **ENTER** button.

The concentration value of the selected log data is displayed.

Press the **ESC** button to return to the screen in the step 1.

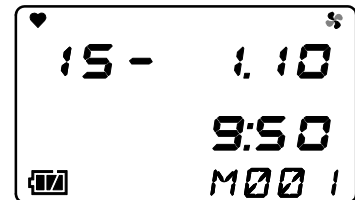

### 4 Press the **ENTER** button.

When the log data display is finished, the buzzer blips and the screen in the step 2 returns.

Display example on  
RX-8500

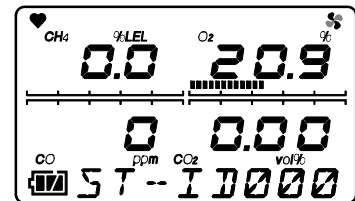

### NOTE

- When the unoperated period lasts about 20 seconds, the screen in the step 1 or 3 is replaced with the measurement screen.

6

# Fault Alarm Function

## Fault alarm activation

"Fault alarm" is triggered when an abnormality is detected in the gas monitor. (Self-latching)  
 In response to a fault alarm, the buzzer sounds and alarm LED arrays blink.

- Sounding buzzer: Repeatedly sounds intermittent beeps at about one-second intervals. "Beep-beep, beep-beep"
- Blinking alarm LED arrays: Repeatedly blinks at about one-second intervals.

**<Fault alarm activation on RX-8500>**

The alarm LED arrays on the top, left and right blink.

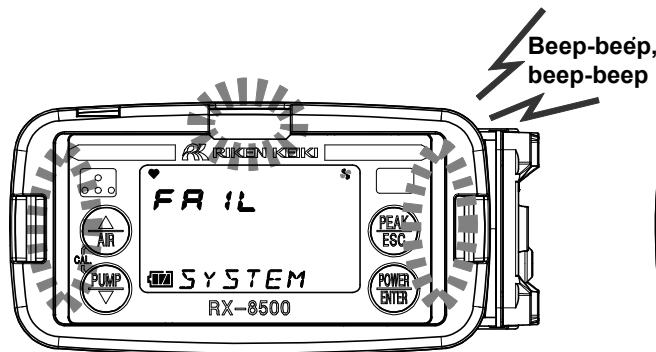

**<Fault alarm activation on RX-8700>**

Only the alarm LED arrays on the top blink.

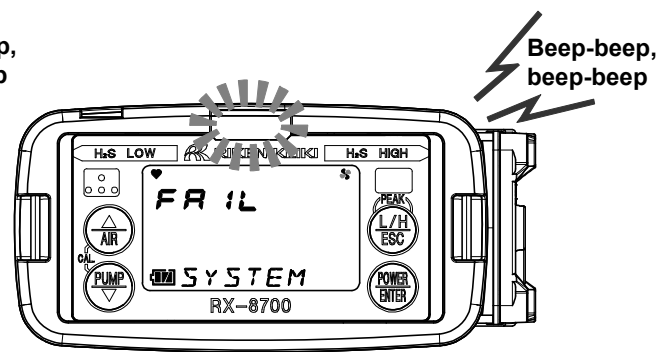

There are following alarm types: low flow rate, battery voltage abnormalities, calibration failure, sensor abnormalities, system abnormalities and clock abnormalities.

The following shows display examples of fault alarms.

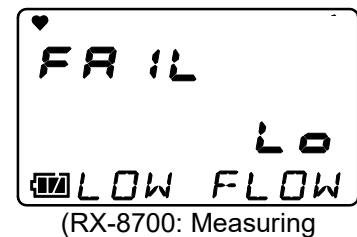
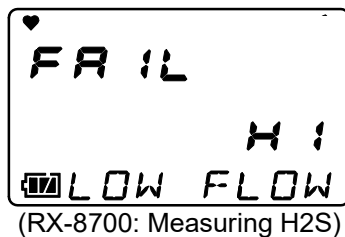
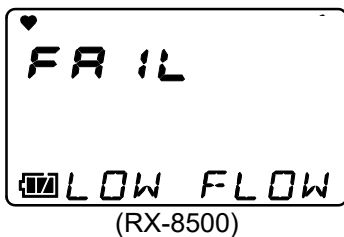

Low flow rate

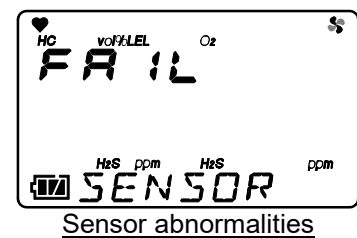
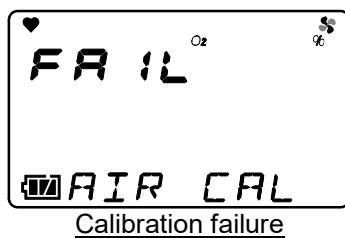
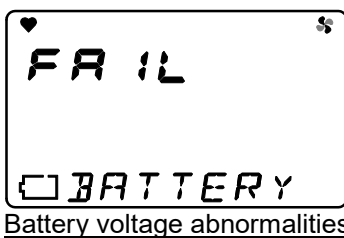

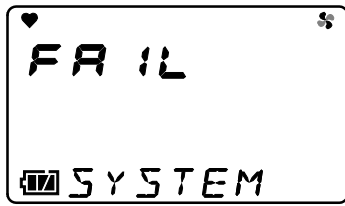

System abnormalities

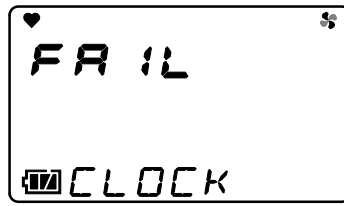

Clock abnormalities

If a fault alarm is triggered, determine the cause and take appropriate action.

If the gas monitor has problems and is repeatedly malfunctioning, contact RIKEN KEIKI immediately.

#### NOTE

- For information on malfunctions (error messages), see "Troubleshooting" (P. 64).

## 7

# Maintenance

The gas monitor is an important instrument for the purpose of safety. To maintain the performance of the gas monitor and improve the reliability of safety, perform a regular maintenance.

## 7-1. Maintenance intervals and items

Perform the following maintenance regularly before use.

- Daily maintenance: Perform maintenance before beginning to work.
- Regular maintenance: Perform maintenance once or more for every six months to maintain the performance as a safety unit.

Maintenance item	Maintenance content	Daily maintenance	Regular maintenance
<b>Battery level</b>	Check that the battery level is sufficient.	○	○
<b>Concentration display check</b>	Make the gas monitor draw in fresh air. Check that the concentration display value is zero (0, or 20.9 vol% for the oxygen concentration display). If it is not zero (0, or 20.9 vol% for the oxygen concentration display), perform air calibration.	○	○
<b>Flow rate check</b>	Check the flow rate indicator for abnormalities.	○	○
<b>Filter check</b>	Check the dust filter for dust or clogging.	○	○
<b>Span adjustment</b>	Perform span adjustment using a calibration gas.	—	○



### WARNING

- If any abnormality is found in the gas monitor, promptly contact RIKEN KEIKI.

### NOTE

- Perform span adjustment using a calibration gas at least once every six months.
- The span adjustment requires dedicated equipment and creation of calibration gas. Therefore, contact RIKEN KEIKI for span adjustment.
- The built-in sensors of the gas monitor have a validity period and must be replaced regularly.
- The sensor life has expired if, for example, the sensors cannot be calibrated in span adjustment, the readings do not come back after air calibration, or the readings fluctuate. In this case, contact RIKEN KEIKI. Note that the warranty period is one year.

## About maintenance services

**We provide services on regular maintenance including span adjustment, other adjustments and maintenance.**

To make the calibration gas, dedicated tools, such as a gas cylinder of the specified concentration and gas sampling bag, must be used.

Our qualified service engineers have expertise and knowledge on the dedicated tools used for services, along with other products. To maintain the safety operation of the gas monitor, please use our maintenance service.

The followings are typical maintenance services. Contact RIKEN KEIKI for more information.

### <Main services>

Item	Details
<b>Battery level check</b>	Checks the battery level.
<b>Concentration display check</b>	Verifies that the concentration display value is zero (0, or 20.9 vol% for the oxygen concentration display) using a zero gas. Performs air calibration if the reading is incorrect.
<b>Flow rate check</b>	Checks the flow rate using an external flow meter.
<b>Filter check</b>	Checks the dust filter for dust or clogging. Replaces a dirty or clogged dust filter.
<b>Span adjustment</b>	Performs span adjustment using a calibration gas.
<b>Cleaning and repair of the unit (visual diagnosis)</b>	Checks dust or damage on the surface of the unit, cleans and repairs such parts. Replaces parts which are cracked or damaged.
<b>Unit operation check</b>	Operates the buttons to check the operation of functions and parameters, etc.
<b>Replacement of consumable parts</b>	Replaces consumable parts, such as a sensor, filter and pump.

## 7-2. Span adjustment

Perform span adjustment of sensors using a calibration gas more than once every six months.

### 7-2-1. Preparation

The zero and span adjustment requires dedicated equipment and a calibration gas. Please contact RIKEN KEIKI .

#### <Required Equipment/Material>

- Calibration gas (optional)
- Gas sampling bag (optional)

### 7-2-2. How to connect

Connect the devices as shown below to perform span adjustment.

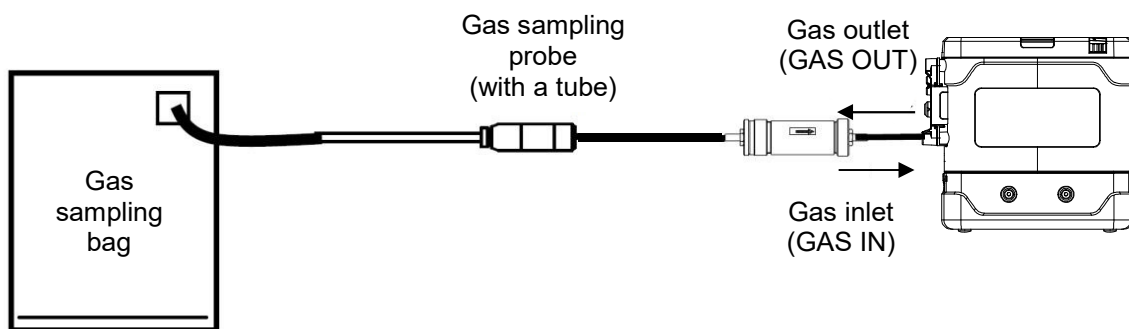

#### WARNING

- Do not apply pressure to the gas sampling bag after attaching it. It may cause a calibration gas to leak inside and result in a calibration failure.

#### Calibration gas

- A calibration gas uses a hazardous gas (combustible gas, toxic gas, oxygen deficiency, etc.). Handle the gas and related jigs and tools with careful attention to the followings.

#### Gas sampling bag

- Use different gas sampling bags for each gas type and concentration to perform accurate calibration.

#### Place for span adjustment

- Do not perform calibration in a confined space.
- Perform span adjustment in a place where no silicone, spray can gases, etc. is used.
- Perform calibration indoors at normal temperatures without remarkable fluctuation (within  $\pm 5^{\circ}\text{C}$ ).
- A calibration gas uses a hazardous gas (combustible gas, toxic gas, oxygen deficiency, etc.). Therefore, be sure to perform calibration in an exhaust booth or collect the calibration gas in an exhaust bag.



#### CAUTION

- Do not use a lighter gas to check the sensitivity of the gas monitor. A constituent of the lighter gas may deteriorate the sensor performances.

## 7-2-3. Span adjustment procedure

Perform the span adjustment using the procedure shown below.

- 1 Prepare an optional calibration gas and set of gas sampling bags.**
- 2 Check that the relay tube, filter tube, gas sampling hose and gas sampling probe are connected to the gas inlet (GAS IN) of the gas monitor.**
- 3 Check that the measurement screen is displayed on the gas monitor.**

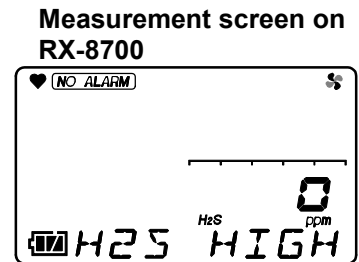
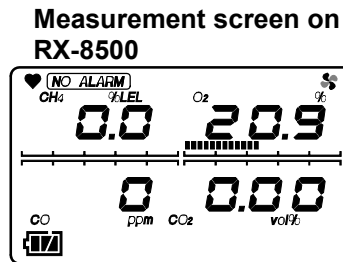

- 4 Perform air calibration.**  
See "4-6. Air calibration". (P. 37)

For RX-8700, perform air calibration in each of the two modes (H2S [high concentration] measuring mode and HC/O2/H2S [low concentration] measuring mode).

- 5 Collect a calibration gas in each gas sampling bag.**
- 6 Hold down the and buttons at the same time on the measurement screen (over one second).**  
The gas monitor enters the calibration mode.
- 7 Select the gas type to be calibrated with the button.**

Pressing the ENTER button while "ESCAPE" is displayed returns to the measurement screen.

<Calibration mode display on RX-8500>

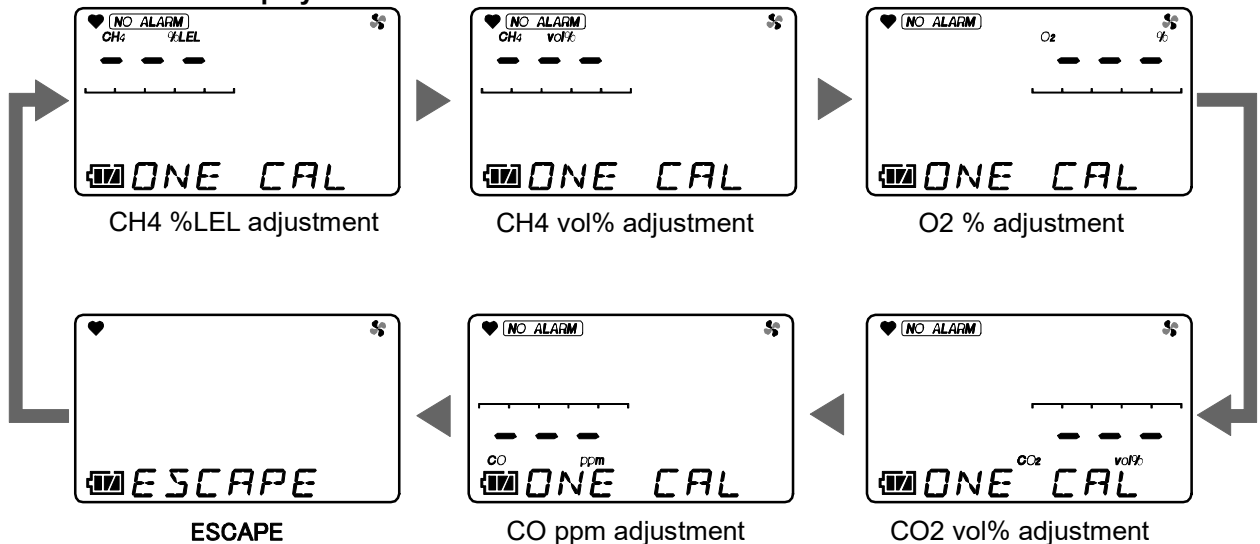

<Calibration mode display on RX-8700>

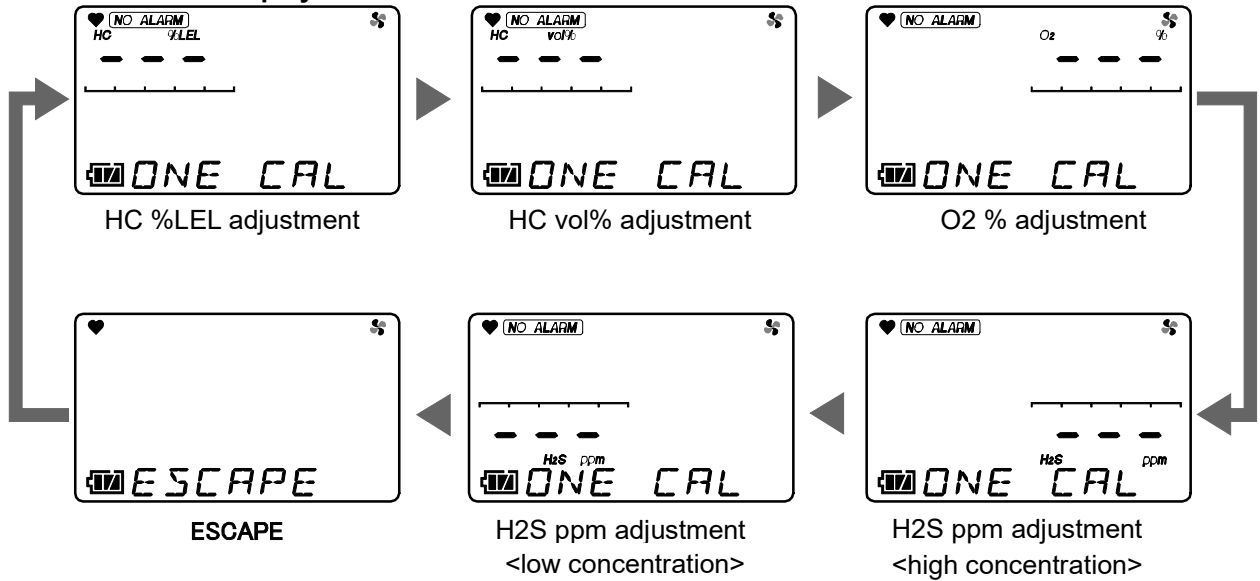

- 8 Press the **ENTER** button when the screen is displayed.  
The concentration display blinks to indicate that calibration is ready.
- 9 Connect the gas sampling bag containing the calibration gas which is the same as the selected gas type to the gas sampling probe connected to the gas monitor. Then introduce the gas into the gas monitor.  
Wait until the concentration display is stabilized.
- 10 When the concentration display is stabilized, adjust it to the calibration gas concentration using the **▲/▼** button.

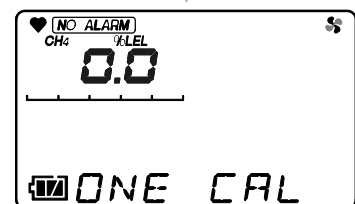
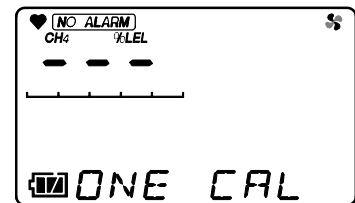

Display example on RX-8500 (Methane (CH<sub>4</sub>) %LEL calibration)



- 11 Press the **ENTER** button.  
"END" appears when the calibration has finished.



**12 Perform calibration for other gas types in the same manner.**

**13 Return to the measurement screen when calibration for all gas types has finished.**

The measurement screen does not return automatically in the calibration mode.



To return to the measurement screen from the calibration mode, press the / button, select "ESCAPE" and then press the  button.



**WARNING**

- Return to the measurement screen when calibration has finished. The measurement screen does not return automatically in the calibration mode.

**NOTE**

- If the  and  buttons are not pressed at the same time, the air calibration (P. 37) screen is displayed. In this case, release both buttons and try again.
- While calibration is in process, press the  button to stop the process. The measurement screen returns.

## 7-3. How to clean

Clean the gas monitor if it becomes extremely dirty. The gas monitor must be turned off while cleaning it. Use a waste cloth or the like to remove dust. Do not use water or organic solvent for cleaning because they may cause malfunctions.

If the inside of the gas sampling hose is extremely contaminated, clean it with dry air, etc. to avoid adverse influence on gas measurement.



### CAUTION

- When cleaning the gas monitor, do not splash water over it or use organic solvents such as alcohol and benzene on it. Otherwise, it may cause discoloration or damage to the surface of the gas monitor or a sensor failure.

### NOTE

- When the gas monitor gets wet, water may remain in the buzzer sound opening or grooves. Drain water as follows:
  - (1) Wipe away moisture on the gas monitor thoroughly using a dry towel, cloth, etc.
  - (2) While holding the gas monitor firmly, shake it about ten times with the buzzer sound opening facing downward.
  - (3) Wipe away moisture coming out from the inside thoroughly using a towel, cloth, etc.
  - (4) Place the gas monitor on a dry towel, cloth, etc. and let it stand at normal temperatures.

## 7-4. Parts replacement

### 7-4-1. Sensor replacement

The built-in sensors of the gas monitor must be replaced regularly. See the regular replacement parts (P. 61) for recommended replacement intervals.

The sensor life has expired if, for example, the sensors cannot be adjusted in calibration, the readings do not come back after air calibration, or the readings fluctuate. In this case, contact RIKEN KEIKI.

### 7-4-2. Replacement procedure for gas sampling probe dust filter

The gas sampling probe has a built-in dust filter. Because the dust filter may gradually get dirty or clogged over time, it must be replaced regularly according to the operating conditions. It must be replaced especially when it shows a sign of water absorption, low flow rate or contamination.

- 1 Rotate the end of the probe counterclockwise and remove it.**

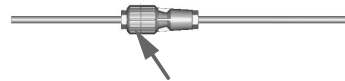

**A round dust filter is contained here. Check it for contamination or clogging. Replace the dust filter if it is contaminated heavily or clogged.**

- 2 Take out the filter and replace it with new one.**
- 3 Reattach the filter case.**

#### NOTE

- Use only the filters specified by RIKEN KEIKI.
- The dust filter of the gas sampling probe is different from that of the filter tube. Use the specified filter for each part.
- See the regular replacement parts (P. 61) for a replacement filter.

### 7-4-3. Replacement procedure for filter tube dust filter

- 1 Loosen the cap (black) and remove it.**

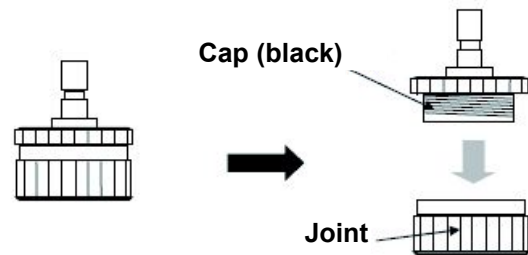

- 2 As shown in the right figure, take out the dust filter from the cap (black) and replace it with new one.**

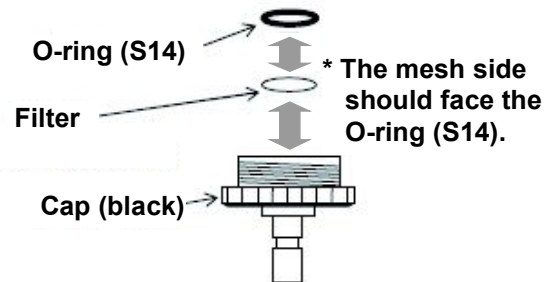

- 3 Reattach the cap (black).**

#### NOTE

- Use only the filters specified by RIKEN KEIKI.
- The dust filter of the gas sampling probe is different from that of the filter tube. Use the specified filter for each part.
- See the regular replacement parts (P. 61) for a replacement filter.

### 7-4-4. Replacement procedure for filter tube absorbent cotton

- 1 Cut an absorbent cotton to the size shown in the right figure (about 1.3 g) and round it into a shape.**

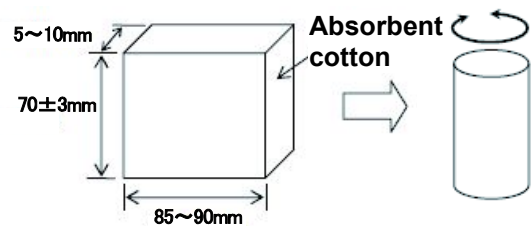

- 2 Loosen the cap and remove it.**

- 3 Replace the absorbent cotton.**  
Put the absorbent cotton into the pipe without a gap between the pipe and cotton.

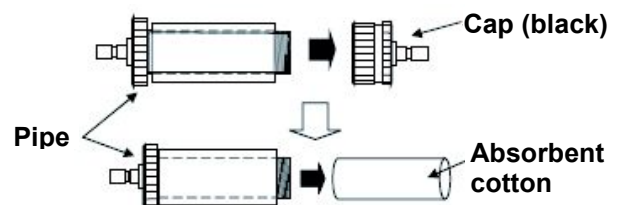

- 4 Reattach the cap (black).**

### 7-4-5. Replacement of regular replacement parts

Replace the regular replacement parts of the gas monitor according to the recommended intervals.

#### <List of Recommended Regular Replacement Parts>

Item	Maintenance intervals	Replacement intervals	Quantity	Remarks
Internal filter	6 months	6 months - 1 year	1 pc	*
Dust filter (10 pcs for gas sampling probe)	6 months	6 months - 1 year	1 pc	Part number 4181 5452 30
Dust filter (10 pcs for filter tube)	6 months	6 months - 1 year	1 pc	Part number 4777 9022 50
Absorbent cotton (25 g for filter tube)	6 months	6 months - 1 year	1.3 g	Part number 1879 0011 10
CO2 removal filter	6 months	1 year	1 pc	RX-8500 only Part number 0913 0028 30
Combustible gas (CH <sub>4</sub> )/ carbon dioxide (CO <sub>2</sub> ) sensor	6 months	5 years	1 pc	RX-8500 only*
Carbon monoxide (CO) sensor	6 months	1 year	1 pc	RX-8500 only*
Oxygen (O <sub>2</sub> ) sensor	6 months	1 year	1 pc	Shared by RX-8500 and RX-8700*
Combustible gas (HC) sensor	6 months	5 years	1 pc	RX-8700 only*
Hydrogen sulfide (H <sub>2</sub> S) [low concentration] sensor	6 months	1 year	1 pc	RX-8700 only*
Hydrogen sulfide (H <sub>2</sub> S) [high concentration] sensor	6 months	1 year	1 pc	RX-8700 only*
Pump unit (RP-11)	6 months	1 - 2 years	1 pc	*
Rubber seals	-	2 years	1 set	*
Tubes	6 months	3 - 8 years	1 set	*
Protection film (5 pcs)	-	-	1 pc	Part number 4777 9025 70
Lithium ion battery pack (For BUL-8000)	-	-	1 pc	About 500 cycles of charging and discharging
Alkaline dry battery (For dry battery unit BUD-8000)	-	-	3 pcs	AA type. When alkaline dry battery unit is used.

\* The operation must be checked after replacement by a qualified service engineer. For the stable operation of the gas monitor and safety, ask a qualified service engineer to take care of replacement of the parts. Please contact RIKEN KEIKI.

#### NOTE

- The above replacement intervals are recommendation only. The intervals may change depending on the operating conditions. These intervals do not mean the warranty periods either. The result of the regular maintenance may determine when to replace the parts.

## 8

# Storage and Disposal

## 8-1. Procedures to store the gas monitor or leave it for a long time

The gas monitor must be stored under the following environmental conditions.

- In a dark place under the normal temperature and humidity away from direct sunlight
- In a place where gases, solvents, vapors, etc. are not present

Store the gas monitor in a shipping carton, if any, in which the product was delivered.  
Store the gas monitor away from dust, etc. if the shipping carton is not available.



### CAUTION

- If the gas monitor is not used for a long time, store it after removing the batteries from the dry battery unit. Leaks from dry batteries may result in fire or injury. If the gas monitor is not used for a short time, store it without removing the batteries. Since the sensor of the gas monitor is energized at all times including power-off time, it is necessary to store the gas monitor with the batteries in it.
- If the gas monitor is not used for a long time, turn on the power at least once every six months and check that the pump draws in air (about three minutes). The gas monitor, when not activated for a long time, may cease to work because of hardening of the grease in the pump motor.

### NOTE

- If the gas monitor with the lithium ion battery unit attached is not used for a long time, it is recommended to store it after discharging the batteries until the battery level icon shows one battery mark or so. If the gas monitor is stored with the batteries fully charged, the batteries get deteriorated more quickly and may have shorter life.
- If the gas monitor with the dry battery unit attached is not used for a short time, store it with dry batteries attached. Since the sensor of the gas monitor is energized at all times including power-off time, it is required to keep dry batteries attached for storage.

## 8-2. Procedures to use the gas monitor again

When using the gas monitor after storage, perform calibration.



### CAUTION

- Contact RIKEN KEIKI for readjustment including calibration.
- If there is a sudden temperature change of 15°C or more between the storage and operational locations, turn on the power of the gas monitor, let it stand for about 10 minutes in a similar environment to the operational location, and perform air calibration in fresh air before using it.

## 8-3. Disposal of products

When the gas monitor is disposed of, it must be treated properly as an industrial waste in accordance with the local regulations.



### WARNING

- Do not disassemble the carbon monoxide, hydrogen sulfide or oxygen sensor because it contains electrolyte. Electrolyte may cause severe skin burns if it contacts skin, while it may cause blindness if it contacts eyes. If electrolyte is adhered on your clothes, that part on your clothes is discolored or its material is decomposed.  
If contact occurs, rinse the area immediately with a large quantity of water. Dispose of batteries in accordance with procedure specified by the local authority.

### <Disposal in EU Member States>

When disposing of the gas monitor in EU member states, sort the batteries as specified. Handle the batteries removed from the lithium ion battery unit (BUL-8000) or dry batteries used for the dry battery unit (BUD-8000) according to the classified refuse collection system and recycling system based on the regulations of EU member states.

### <Removing battery of lithium ion battery unit>

Remove the lithium ion battery unit with reference to "Charging the lithium ion battery unit (BUL-8000)" (P. 24).

### <Removing batteries>

Remove batteries with reference to "Attaching batteries to the dry battery unit (BUD-8000, option)" (P. 26).

### NOTE

#### Crossed-out recycle dustbin mark

- This symbol mark is indicated on the products which contain the batteries which fall under EU Battery Directive 2006/66/EC. Such batteries need to be disposed of as specified by the latest Directive. This symbol mark indicates that the batteries need to be separated from the ordinary waste and disposed of appropriately.



## 9

# Troubleshooting

The troubleshooting does not explain the causes of all the malfunctions which may occur on the gas monitor. This simply helps to find the causes of malfunctions which may frequently occur. If the gas monitor shows a symptom which is not explained in this manual, or still has malfunctions even though remedial actions are taken, please contact RIKEN KEIKI.

## 9-1. Abnormalities on unit

Symptoms	Causes	Actions
The power cannot be turned on.	The battery level is too low.	Lithium ion battery unit: Charge in a safe place. Dry battery unit: Replace all the three dry batteries with new ones in a safe place.
	The <b>POWER</b> button was released quickly.	For power-on, keep the <b>POWER</b> button pressed until a blip is heard.
	Improper installation of the battery unit	Check whether the battery unit is properly attached to the main unit.
Abnormal operations	Disturbances by sudden static electricity noise, etc.	Turn off the power once and then turn it on again (restart).
Cannot operate the gas monitor.	Disturbances by sudden static electricity noise, etc.	Remove the battery unit in a safe place. Then reinstall it and turn on the power to perform operations.
System abnormalities <b>FAIL SYSTEM</b>	A circuit abnormality occurred.	Please contact RIKEN KEIKI for repair.
Sensor abnormalities <b>FAIL SENSOR</b>	A sensor has failed.	Please contact RIKEN KEIKI to replace the sensor. (If "FAIL" is displayed in place of measured value at power-on, the alarm can be reset by pressing the <b>ESC</b> button. The operation can be continued using only the normal sensors to detect other gases.)
A low battery voltage alarm is displayed. <b>FAIL BATTERY</b>	The battery level is low.	Lithium ion battery unit: Turn off the power and charge it in a safe place.
		Dry battery unit: Turn off the power and replace the dry batteries with new ones in a safe place.

<b>A low flow rate alarm is displayed.</b> <b>FAIL LOW FLOW</b>	Water, oil or the like is drawn.	Check the gas sampling hose for any damage or mark of drawn water, oil, etc.
	The gas sampling hose is clogged.	Check the gas sampling hose for connections, clogging, twisting, etc.
	The gas monitor was powered on at a low temperature or has not been used for a long time.	Cycle the power several times. The pump may start operating.
	The pump has deteriorated.	Please contact RIKEN KEIKI to replace the pump.
<b>Air calibration impossible</b> <b>FAIL AIR CAL</b>	Fresh air is not supplied around the gas monitor.	Draw fresh air properly and perform air calibration again. (P. 23)
	A sensor has failed.	Please contact RIKEN KEIKI for repair.
<b>Clock abnormalities</b> <b>FAIL CLOCK</b>	Abnormalities of the internal clock	Make a setting of date/time. If a symptom like this is observed repeatedly, the built-in clock is seemingly malfunctioning. Thus, it must be replaced. Please contact RIKEN KEIKI.
<b>The batteries cannot be charged.</b> <b>(Lithium ion battery unit only)</b>	The charger is not connected properly.	Connect the AC plug and DC plug of the AC adapter properly.
	A charging circuit abnormality occurred.	Please contact RIKEN KEIKI for repair..
	The batteries have been fully charged.	When fully charged batteries are charged again, the charging indicator lamp does not go on.

## 9-2. Abnormalities of readings

Symptoms	Causes	Actions
<b>The reading rises (drops) and it remains so.</b>	Drifting of sensor output	Perform the air calibration. (P. 37)
	Presence of interference gas	Disturbances by interference gases, such as solvents, cannot be eliminated completely. Contact RIKEN KEIKI for measures to take, such as a use of removal filter.
	Slow leak	A very small amount of the gas to be measured may be leaking (slow leak). Because ignoring it may cause dangers, take actions and measures which are taken at an occurrence of gas alarm.
	Environmental changes	Perform the air calibration. (P. 37) In particular, the oxygen sensor is affected by the air pressure.
<b>Slow response</b>	Clogged dust filter	Replace the dust filter. (P. 59)
	Bended or clogged gas sampling hose	Fix the defective parts.
	Condensation is formed inside the gas monitor.	Fix the defective parts.
	Deteriorated sensor sensitivity	Please contact RIKEN KEIKI to replace the sensor.
<b>Span adjustment impossible</b>	Improper calibration gas concentration	Use the proper calibration gas.
	Deteriorated sensor sensitivity	Please contact RIKEN KEIKI to replace the sensor.

## 10

# Product Specifications

## 10-1. RX-8500 specifications

### 10-1-1. List of RX-8500 specifications

Measuring gas	Combustible gas (CH <sub>4</sub> )	Oxygen (O <sub>2</sub> )	Carbon monoxide (CO)	Carbon dioxide (CO <sub>2</sub> )
Measuring principle	Non-dispersive infrared type	Galvanic cell type	Electrochemical type	Non-dispersive infrared type
Measuring range <Service range>	0 - 100.0% LEL/ 5 - 100.0 vol%	0 - 25.0 vol% <25.1 - 40.0 vol%>	0 - 1000 ppm	0 - 20.0 vol%
Minimum resolution	0.5% LEL (0 - 100.0% LEL) 0.5 vol% (5.0 - 100.0 vol%)	0.1vol%	1ppm	0.01 vol% (0 - 2.00 vol%) 0.05 vol% (2.00 - 5.00 vol%) 0.1 vol% (5.00 - 20.0 vol%)
Concentration display	LCD digital (7-segment + Symbol + Bar meter)			
Sampling method	Sample-drawing			
Suction flow rate	0.75 L/min or more (Open flow rate)			
Displays	Battery level icon, pilot indicator, and pump operation status indicator			
Buzzer sound volume	95 dB (A) or higher (30 cm)			
Fault alarm/self diagnosis	Low flow rate, battery voltage abnormalities, calibration failure, sensor abnormalities, system abnormalities and clock abnormalities.			
Fault alarm display	Lamp blinking, intermittent buzzer sounding, and detail display			
Fault alarm pattern	Self-latching			
Transmission method	IrDA (for data logger)			
Functions	LCD backlight, peak display, pump stop, data logger and log data display			
Power supply	Dedicated lithium ion battery unit [BUL-8000(Z1)] <Standard> Or dedicated dry battery unit <AA alkaline dry battery <sup>*1</sup> x 3> [BUD-8000(Z)] <Option>			
Continuous operating time	BUL-8000 [BUL-8000(Z1)]: About 15 hours (25°C, no alarm, no lighting and battery fully charged) <Standard> BUD-8000 [BUD-8000(Z)]: About 8 hours (25°C, no alarm and no lighting) <Option>			
Operating temperatures	-20 - +50°C			
Operating humidities	Below 95% RH (Non-condensing)			
Structure	Drip-proof and dust-proof performances (compliant to IP67 level)			

<b>Explosion-proof structure</b>	Intrinsically safe explosion-proof structure
<b>Explosion-proof class</b>	Ex ia IIC T4 Ga (ATEX/IECEEx<Presafe>)
<b>Dimensions</b>	Approx. 154 (W) x 81 (H) x 163 (D) mm (projection portions excluded)
<b>Weight</b>	About 1.2 kg (with BUL-8000(Z1)) <Standard> or about 1.1 kg (with BUD-8000(Z)) <Option>

\*1 Use AA alkaline batteries (LR6) produced by TOSHIBA CORPORATION to meet the conditions for explosion-proof performance.

### 10-1-2. RX-8500 standard accessories

	<ul style="list-style-type: none"> <li>• Lithium ion battery unit : 1 pc (attached to main unit)</li> <li style="padding-left: 20px;">(BUL-8000) : 1 pc</li> <li>• AC adapter for charging : 1 pc</li> <li>• Gas sampling probe and gas sampling hose : 1 pc</li> <li>• Filter tube (CF-8385) : 1 pc</li> <li>• Relay tube : 2 pcs</li> <li>• Absorbing tube fixing belt : 1 pc</li> <li>• Shoulder strap : 1 pc</li> <li>• CO2 removal filter : 1 pc</li> <li>• CO2 filter fixing belt</li> </ul>
--	--

## 10-2. RX-8700 specifications

### 10-2-1. List of RX-8700 specifications

Measuring gas	Combustible gas* <sup>1</sup> (HC)	Oxygen (O <sub>2</sub> )	Hydrogen sulfide (H <sub>2</sub> S)	
Measuring principle	Non-dispersive infrared type	Galvanic cell type	Electrochemical type	
Measuring range <Service range>	0 - 100.0% LEL/ 2 - 100.0 vol%	0 - 25.0 vol% <25.1 - 40.0 vol%>	[Low concentration] 0 - 30.0 ppm <30.5 - 100.0 ppm>	[High concentration] 0 - 1000 ppm
Minimum resolution	0.5% LEL (0 - 100.0% LEL) 0.5 vol% (5.0 - 100.0 vol%)	0.1vol%	0.5ppm	1ppm
Concentration display	LCD digital (7-segment + Symbol + Bar meter)			
Sampling method	Sample-drawing			
Suction flow rate	0.75 L/min or more (Open flow rate)			
Displays	Battery level icon, pilot indicator, and pump operation status indicator			
Buzzer sound volume	95 dB (A) or higher (30 cm)			
Fault alarm/self diagnosis	Low flow rate, battery voltage abnormalities, calibration failure, sensor abnormalities, system abnormalities and clock abnormalities.			
Fault alarm display	Lamp blinking, intermittent buzzer sounding, and detail display			
Fault alarm pattern	Self-latching			
Transmission method	IrDA (for data logger)			
Functions	LCD backlight, peak display, pump stop, data logger and log data display			
Power supply	Dedicated lithium ion battery unit [BUL-8000(Z1)] <Standard> Or dedicated dry battery unit <AA alkaline dry battery <sup>2</sup> x 3> [BUD-8000(Z)] <Option>			
Continuous operating time	BUL-8000 [BUL-8000(Z1)]: About 15 hours (25°C, no alarm, no lighting and battery fully charged) <Standard> BUD-8000 [BUD-8000(Z)]: About 8 hours (25°C, no alarm and no lighting) <Option>			
Operating temperatures	-20 - +50°C			
Operating humidities	Below 95% RH (Non-condensing)			
Structure	Drip-proof and dust-proof performances (compliant to IP67 level)			
Explosion-proof structure	Intrinsically safe explosion-proof structure			
Explosion-proof class	Ex ia IIC T4 Ga (ATEX/IECEX<Presafe>)			
Dimensions	Approx. 154 (W) x 81 (H) x 163 (D) mm (projection portions excluded)			
Weight	About 1.3kg (with BUL-8000(Z1)) <Standard> or about 1.2kg (with BUD-8000(Z)) <Option>			

\*1 The combustible gas HC concentration is displayed in isobutane conversion.

\*2 Use AA alkaline batteries (LR6) produced by TOSHIBA CORPORATION to meet the explosion-proof conditions.

**10-2-2. RX-8700 standard accessories**

	<ul style="list-style-type: none"><li>• Lithium ion battery unit : 1 pc (attached to main unit)</li><li>  (BUL-8000(Z1)) : 1 pc</li><li>• AC adapter for charging : 1 pc</li><li>• Gas sampling probe and gas   sampling hose : 1 pc</li><li>• Filter tube (CF-8385) : 1 pc</li><li>• Relay tube : 2 pcs</li><li>• Absorbing tube fixing belt : 1 pc</li><li>• Shoulder strap</li></ul>
--	---

## 10-3. List of optional items

<p><b>Optional items (sold separately)</b></p>	<p>Leather case</p> <p>Sampling probe holder</p> <p>Waist strap</p> <p>Waist strap fixing tool</p> <p>Protection film</p> <p>Protection film (5 pcs)</p> <p>Lithium ion battery unit (BUL-8000)</p> <p>AC adapter</p> <p>AC adapter replacement plug</p> <p>Dry battery unit (BUD-8000)</p> <p>AA alkaline battery (TOSHIBA)</p> <p>Absorbent cotton (for CF-8385)</p> <p>Dust filter (10 pcs) (for CF-8385)</p> <p>Dust filter (10 pcs) (for gas sampling probe)</p> <p>Data logger management program</p> <p>Demand flow valve</p> <p>Trap filter</p> <p>Sampling hose with weight (30 m)</p> <p>Sampling hose with float (30 m)</p> <p>Aluminum trunk case (RoHS compliant)</p> <p>Aluminum trunk case (non RoHS compliant)</p> <p>Shipboard storage box (metal, RoHS compliant)</p> <p>Set of gas sampling bags</p> <p>Calibration gas can (0.6 L N<sub>2</sub>: 99.99% or more)</p> <p>Calibration gas can (0.6 L i-C<sub>4</sub>H<sub>10</sub>: 50% LEL, Air: balance)</p> <p>Calibration gas can (0.6 L i-C<sub>4</sub>H<sub>10</sub>: 10%, N<sub>2</sub>: balance)</p> <p>Calibration gas can (0.6 L CH<sub>4</sub>: 70% LEL, N<sub>2</sub>: balance)</p> <p>Calibration gas can (0.6 L CH<sub>4</sub>: 70%, N<sub>2</sub>: balance)</p> <p>Calibration gas can (0.6 L CO<sub>2</sub>: 10%, N<sub>2</sub>: balance)</p> <p>Calibration gas can (0.6 L CO: 145 ±5 ppm, N<sub>2</sub>: balance)</p> <p>Hydrogen sulfide calibration gas kit (CK-82)</p>
--	---



### CAUTION

Be sure to use the sampling hose with weight (30 m) in combination with the filter tube (CF-8385) for dust removal and water-proof performance.  
If water, etc. is drawn while the filter tube is unattached, it enters the inside of the unit and causes a trouble.

## 11

# Appendix

## 11-1. Definition of terms

<b>vol%</b>	Gas concentration indicated in the unit of one-hundredth of the volume
<b>ppm</b>	Gas concentration indicated in the unit of one-millionth of the volume
<b>LEL</b>	The acronym of Lower Explosive Limit. LEL refers to the lowest concentration of a combustible gas in air capable of causing explosion when ignited.
<b>Self-latching</b>	One of alarm patterns. Once an alarm is triggered, this keeps the alarm activated until it is reset even when the alarm conditions are not met.

## 11-2. Calibration history/various trend/event history functions

The gas monitor has history and trend functions. To use this function, please contact RIKEN KEIKI.

### NOTE

- The data logger management program (optional) is required to use the history and trend functions. Contact RIKEN KEIKI for more information.

Data logger provides five functions.

### (1) Interval trend

Records the change of measured concentration from power-on to power-off.

Up to 100 latest data are recorded.

After the number of recorded data reaches 100, the oldest data will be overwritten by the latest data.

\* However, when the maximum recording time is exceeded, the oldest data will be deleted before reaching 100.

The maximum recording time is specified as follows for each interval time.

Interval time	10-second	20-second	30-second	1-minute	3-minute	5-minute	10-minute
Maximum recording time	10 hours	20 hours	30 hours	60 hours	180 hours	300 hours	600 hours

\* The standard interval time is "5 minutes."

Interval time can be set by "Data Logger Management Program" (optional).

**(2) Alarm trend**

Starting immediately after the alarm is triggered, this function records the change of measured concentration for one hour, which is from 30 minutes before the alarm was triggered until 30 minutes after the alarm was triggered.

Alarm trend records the peak value of five-second time at a 5-second interval.

Last eight measurement data shall be recorded.

When the number of data exceeds eight, the oldest data will be overwritten by the latest data.

**(3) Alarm event**

Records the trigger of alarm as an event.

The event records the time of alarm trigger, target measuring gas and type of alarm event (full scale, first or second alarm setpoint).

Up to 100 latest events are recorded.

After the number of recorded events reaches 100, the oldest data will be overwritten by the latest data.

**(4) Trouble event**

Records the trigger of fault alarm as an event.

The event records the time when the trouble was triggered, the target gas of measurement, and the type of fault event.

Up to 100 latest events are recorded.

After the number of recorded events reaches 100, the oldest data will be overwritten by the latest data.

**(5) Calibration history**

Records data when the calibration is performed.

The history records the calibration time, concentration values before and after the calibration, as well as the calibration error.

Up to 100 latest calibration data are recorded.

After the number of recorded data reaches 100, the oldest data will be overwritten by the latest data.

**NOTE**

- 
- The data logger function of this gas monitor is entirely based on the overwriting system (the oldest data is deleted and the latest data is recorded).
  - The recorded data can be read out by the "Data Logger Management Program" (optional). See the operating manual of "Data Logger Management Program" for more information.
-

## 11-3. Gas alarm (optional function)

Normally the gas alarm function is set to OFF and unavailable (optional function). To use this function, please contact RIKEN KEIKI.

Gas alarm: Triggered when the concentration of detected gas reaches or exceeds the alarm setpoint value. (Self-latching)

Alarm display: Notifies users of an alarm by blinking the concentration display of the subject gas, sounding the buzzer and lighting the lamp.

Alarm types: First alarm (WARNING), second alarm (ALARM) and OVER alarm

### <List of Gas Alarms>

Gas alarm type	First alarm	Second alarm	OVER alarm
<b>Sounding buzzer</b>	Repeatedly sounds strong and weak beeps at about 1-second intervals. "Beep, beep"	Repeatedly sounds strong and weak beeps at about 0.5 second intervals: "Beep, beep, beep, beep"	Repeatedly sounds strong and weak beeps at about 0.5 second intervals: "Beep, beep, beep, beep"
<b>Blinking alarm LED arrays</b>	Repeatedly blinks at about 1-second intervals.	Repeatedly blinks at about 0.5-second intervals.	Repeatedly blinks at about 0.5-second intervals.
<b>Vibration</b>	Vibrate at an alarm state.		
<b>LCD display</b>	Blinks the gas concentration and WARNING displays.	Blinks the gas concentration and ALARM displays.	Blinks the gas concentration and OVER displays.

# Declaration of Conformity

We, **RIKEN KEIKI CO., LTD.**

2-7-6, Azusawa, Itabashi-ku,  
Tokyo 174-8744 Japan

declare in our sole responsibility that the following  
product conforms to all the relevant provisions.

Product Name	:	Portable Gas Monitor
Model Name	:	RX-8500•RX-8700
Council Directives	:	EMC : 2014/30/EU
		ATEX : 2014/34/EU
		RoHS : 2011/65/EU
Applicable Standards	:	EMC : EN 50270:2015(Type2)
		ATEX : EN 60079-0:2012
		EN 60079-11:2012
		EN60079-26:2007
		RoHS : EN50581(2012)
Name and address of the ATEX Notified Body	:	DNV Nemko Presafe AS (NB 2460) Veritasveien 3 1363 Høvik Country : Norway
Number of the EU type examination certificate	:	Presafe 15 ATEX 6173 21 April 2015
Name and address of the ATEX Auditing Organization	:	SGS Baseefa Ltd. (NB 1180) Rockhead Business Park Staden Lane SK17 9RZ BUXTON United Kingdom
The Marking of the equipment or protective system shall include the following	:	II 1G Ex ia II C T4 Ga

Year to begin affixing CE Marking : 2018

Place: TOKYO, Japan

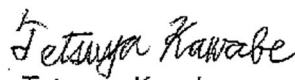
Signature:   
Full name: Tetsuya Kawabe

Date: Nov. 29, 2018

Title: Director, Quality control center