



PT0E-1331

Operating Manual for
Formaldehyde Gas Detector
FP-31

RIKEN KEIKI Co., Ltd.

2-7-6 Azusawa, Itabashi-ku, Tokyo, 174-8744, Japan

Phone : +81-3-3966-1113

Fax : +81-3-3558-9110

E-mail : intdept@rikenkeiki.co.jp

Web site : <http://www.rikenkeiki.co.jp/>

Contents

1 Product Outline.....	3
Preface.....	3
Purpose of use.....	3
Definition of DANGER, WARNING, CAUTION and NOTE	4
2 Important Notice on Safety.....	5
2-1. Warning cases.....	5
2-2. Precautions.....	6
3 Product Components.....	8
3-1. Main unit and standard accessories.....	8
3-2. Names and functions for each part	10
3-3. Detection TAB.....	12
4 How to Use.....	13
4-1. Before using the detector	13
4-2. Preparation for start-up	13
4-3. How to start the detector	15
4-4. Mounting of detection TAB	18
4-5. How to detect.....	19
4-6. Preliminary sample drawing	24
4-7. Purge	25
4-8. Change in date and time	26
4-9. Power-off	27
5 Self-diagnostic.....	28
6 Maintenance.....	29
6-1. Maintenance intervals and items.....	29
6-2. How to clean.....	30
6-3. Consumables.....	30
7 Storage and Disposal	31
7-1. Procedures to store the detector or leave it for a long time.....	31
7-2. Procedures to use the detector again	31
7-3. Disposal of products.....	31
8 Troubleshooting	32
9 Product Specifications.....	34
10 Appendix.....	35
10-1. Detection principle.....	35

1

Product Outline

Preface

Thank you for choosing our HCHO DETECTOR FP-31 (hereinafter referred to as the detector). Please confirm the model number of the product you purchased and how to use this manual.

This manual describes how to use the detector properly and its specifications. Not only the first-time users but also the users who have already used the detector must read and understand the operating manual and use this product as described in this manual.

Note that the contents of this manual are subject to change without notice for product improvement. It is also prohibited to copy or reproduce this manual, in whole or in part, without permission.



Regardless of warranty period, we shall not make any indemnification for accidents and damage caused by using the detector. Make sure to read the warranty policy specified on the warranty.

Purpose of use

The detector is used with a dedicated detection TAB mounted on it to detect formaldehyde PPM level and display the gas concentration on its display. Detection results are not intended to guarantee life or safety in any way.

Definition of DANGER, WARNING, CAUTION and NOTE

Throughout this manual, the following indications are used to ensure safe and effective work.

 DANGER	This message indicates that improper handling may cause serious damage on life, health or assets.
 WARNING	This message indicates that improper handling may cause serious damage on health or assets.
 CAUTION	This message indicates that improper handling may cause minor damage on health or assets.
NOTE	This message indicates advice on handling.

2

Important Notice on Safety

To maintain the performance of the detector and use it safely, observe the following instructions with WARNING and CAUTION.



WARNING

- If any abnormality is found in the detector, promptly contact RIKEN KEIKI. Visit our Web site to find your nearest RIKEN KEIKI office.
Web site: <http://www.rikenkeiki.co.jp/>

2-1. Warning cases



WARNING

- **Sampling point pressure**
The detector is designed to draw in gases around it under the atmospheric pressure. If excessive pressure is applied to the gas inlet and outlet (GAS IN, GAS OUT) of the detector, detected gases may leak out from the inside and may cause dangerous conditions. Be sure that excessive pressure is not applied to the detector during use.
- Do not modify or change the circuit, structure etc. If any modification or change is made, the performance cannot be maintained.
- Also prevent metallic or flammable materials from entering the detector when replacing the detection TAB, etc. If the detector is used while they are in the unit, malfunctions, electric shocks, and fires will be caused.

Battery level check

- Before use, check that there remains sufficient battery power. When the detector is used for the first time or is not used for a long period, the batteries may be exhausted. Replace them with new ones before use.
- If a low battery voltage alarm is triggered, gas detection cannot be conducted. If the alarm is triggered during use, turn off the power and promptly replace the batteries in a safe area.

Others

- Do not throw the detector into fire.
- Do not wash the detector in a washing machine or ultrasonic cleaner.
- Do not remove the battery unit while the power is ON.

2-2. Precautions



CAUTION

- Do not use the detector in a place where it is exposed to oil, chemicals, etc. Do not submerge the detector under water on purpose.
 - Do not use in a place where the detector is exposed to liquids such as oil and chemicals.
 - The gas inlet and outlet are not water-proof. Be careful not to let water such as rainwater get into these parts. Because this may cause trouble and gas cannot be detected.
 - Do not place the detector where water or dirt gets accumulated. The detector placed at such a location may malfunction due to water or dirt that gets into the buzzer opening, gas inlet, etc.
 - Note that drawing in dirty water, dust, metallic powder, etc. will significantly deteriorate the sensor sensitivities. Be careful when the detector is used in an environment where these elements exist.
- Do not use the detector in a place where the temperature drops below -10°C or rises over 40°C .
 - The operating temperature of the detector is -10 to $+40^{\circ}\text{C}$. Do not use the detector at higher temperatures, humidities and pressures or at lower temperatures than the operating range.
 - Avoid long-term use of the detector in a place where it is exposed to direct sunlight.
 - Do not store the detector in a sun-heated car.
- Observe the operating restrictions to prevent condensation inside the detector. Condensation formed inside the detector causes clogging or gas adsorption, which may disturb accurate gas detection. In addition to the installation environment, carefully monitor the temperature/humidity of the sampling point to prevent condensation inside the detector. Please observe the operating restrictions.
- Do not use a transceiver near the detector.
 - Radio wave from a transceiver or the like near the detector may disturb the readings. If a transceiver or other radio wave transmitting device is used, it must be used in a place away from the detector where it disturbs nothing.
 - Do not use the detector near a device that emits strong electromagnetic waves (high-frequency or high-voltage devices).
- Verify that the pump driving indicator is rotating before using the detector. If the flow check display is not rotating, gas detection cannot be performed properly. Check whether the flow rate is lost.
- Never fail to perform a regular maintenance. Never fail to perform a regular maintenance of the detector to ensure safety. Continuing to use the detector without performing maintenance will compromise the sensitivity of the sensor, thus resulting in inaccurate gas detection.
- Others
 - Pressing buttons unnecessarily may change the settings, affecting normal operation of the detector. Operate the detector using only the procedures described in this operating manual.
 - Do not drop or give shock to the detector. The accuracy of the detector may be deteriorated.
- Do not jab the buzzer opening with a sharp-pointed item. The detector may malfunction or get damaged, allowing foreign matter, etc. to get inside.
 - Do not remove the panel sheet on the display. The dust-proof performance will be deteriorated.
 - Do not affix a label or the like on the infrared port. Infrared communications can no longer be conducted.
- About battery replacement
 - Turn off the power of the detector before replacing the batteries.
 - Replace all of the four batteries with new ones at one time.
 - Pay attention to the polarities of the batteries.



CAUTION

- About the use of the detector
 - At low temperatures, the operating time is shortened due to the battery performance property.
 - At a low temperature, the response of the LCD display may get slow down.
 - If there is a sudden temperature change between the storage and operation locations, an error of "TEMP. FAILURE" indicating sudden temperature changes may occur during measurement. After confirming that the temperature of the operation location remains constant, leave the detector under the atmosphere for 30 minutes or more before measurement.
 - When cleaning the detector, do not splash water over it or use organic solvents such as alcohol and benzene on it. The surface of the detector may be discolored or damaged.
 - If the detector is not used for a long time, turn on the power at least once every six months and check that the pump draws in air (about three minutes). The detector, when not activated for a long time, may cease to work because of hardening of the grease in the pump motor.
 - If the detector is not used for a long time, store it after removing the dry batteries. Battery leaks may result in fire, injury, etc.
 - When the detector is used again after a long-period storage, never fail to perform a calibration. Contact RIKEN KEIKI for information on readjustment including calibration.

3

Product Components

3-1. Main unit and standard accessories

After opening the carton box, check the detector and accessories.
If there is anything missing, contact RIKEN KEIKI.

Main unit

For names and functions of individual parts of the detector and LCD display, see "[3-2. Names and functions of individual parts](#)" on page 10.

FP-31 main unit

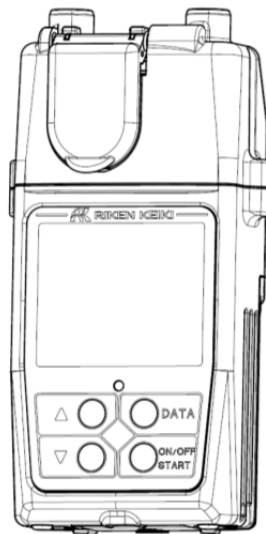

Standard accessories

Detection TAB
20 pcs/bag



AA alkaline dry batteries
4 pcs

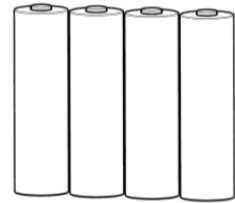

Tripod-mounting
attachment

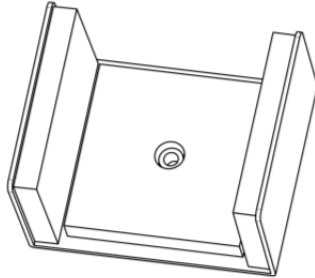

Product warranty
Operating manual

Optional parts

- Filter
- Software for data logger

3-2. Names and functions for each part

This section describes the names and functions of the individual parts and LCD display that make up the detector.

Main unit

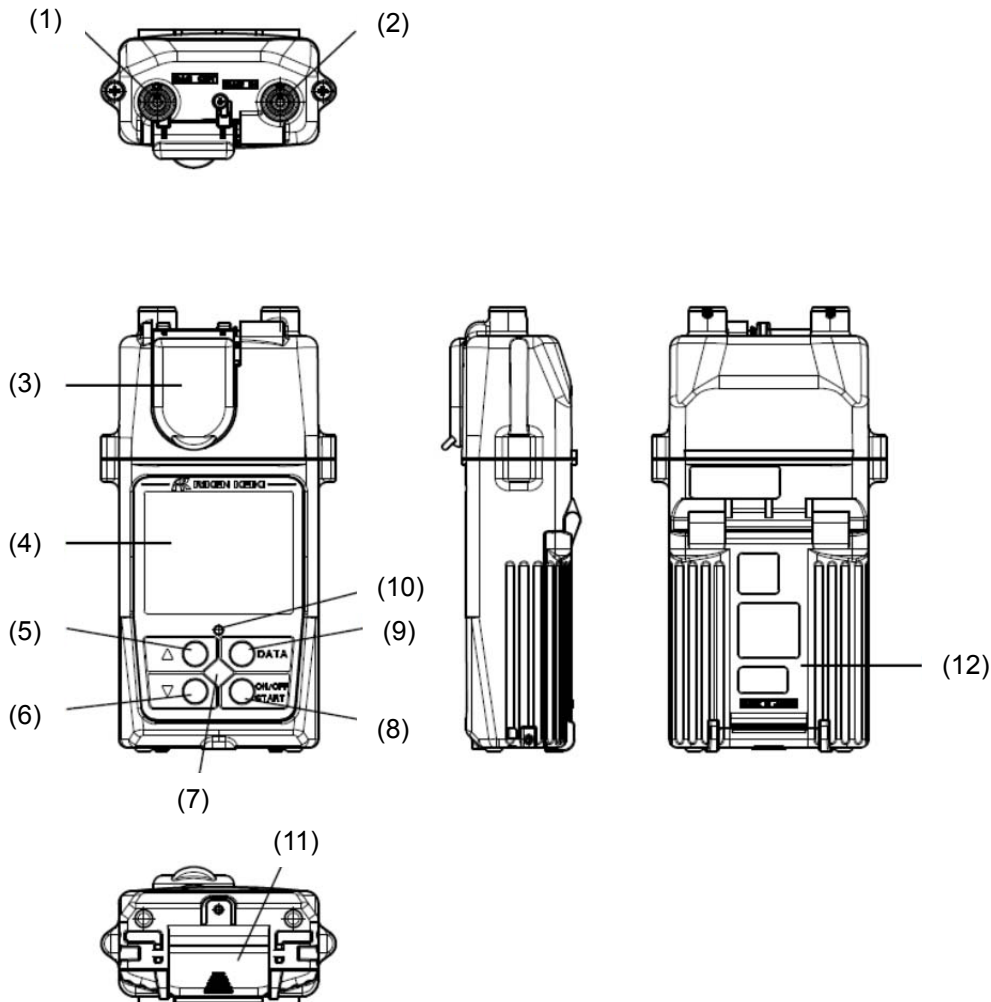

Name	Major function
(1) GAS OUT	Exhausts the gas drawn into the detector. (Do not block it.)
(2) GAS IN	Draws gases into the detector. (Do not block it.)
(3) Detection TAB cover	Raised when the detection TAB is mounted.
(4) LCD display	Displays the gas concentration and so on.
(5) ▲ button	It is used to increase numerical values.
(6) ▼ button	It is used to decrease numerical values.
(7) Infrared communication port	Used to carry out data communications with a PC in data logger mode.
(8) ON/OFF/START button	It is used to turn on or off the power or start detection.
(9) DATA button	It is used to set the past detection data and current date and time.
(10) Buzzer sound opening	Emits operation and judgment sounds. (Do not block it.)
(11) Lock plate	Retains the battery cover.
(12) Battery cover	Protects the battery.

Display

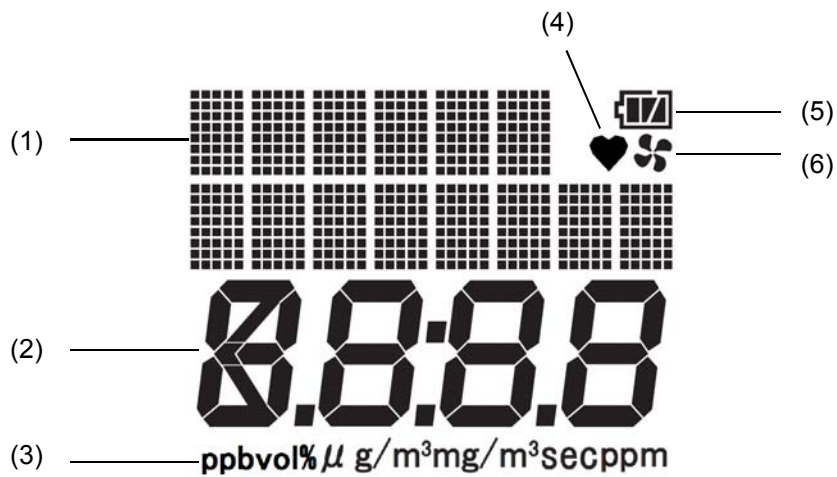

Name	Major function
(1) Gas name and message display	Displays type of measured gas and message.
(2) Gas concentration/Count/Clock display	Displays the gas concentration as numeric output. Displays remaining measurement time in seconds. Displays the current time.
(3) Value/unit display	Displays the unit of a numerical value.
(4) Operating state display	Displays the operating status in the detection mode. Normal: Blinking
(5) Battery level icon	Displays the approximate battery level.
(6) Flow check display	Displays the drawing status. Normal: Rotating

3-3. Detection TAB

The detection TAB is a gas detection unit developed by RIKEN KEIKI. It contains special paper that exhibits a color by contact with gas in a case that uses polypropylene as a material.

Handling of detection TAB

A special reagent is applied to the test paper part of the detection TAB. Be careful not to touch the test paper with fingers or an object when handling the detection TAB.

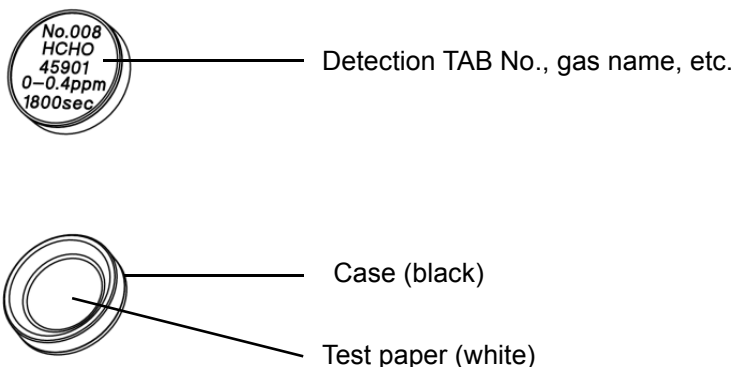

CAUTION

- Do not touch the test paper of the detection TAB. Touching it may impair the detection function. If you touch the test paper, rinse your fingers thoroughly to remove the chemical reagents used on the test paper. These reagents have no direct influence on human body.
- Do not use used detection TABs. The detection TAB can be used for single gas detection. Even if the detection result shows 0 ppm, the second detection with the same detection TAB will not produce an accurate result.

Storage of detection TAB

Fully understand precautions for detection TAB storage before storing them.

Storing improperly the detection TAB may impair its performance, resulting in inaccurate gas detection.

The proper storage location of each detection TAB depends on the type. Store the detection TAB in the storage location indicated on a packing box.



CAUTION

- Store pieces of detection TAB in a packing box in the storage location indicated on the bag.
- Do not store the detection TAB of which packing box was once opened again. If a detection TAB that was once taken out of the packing box is stored or left in the atmosphere or on the detector, it will discolor and can no longer maintain its original performance.
- Use up the detection TAB before the end of the storage period on the packing box. The detection TAB of which storage period has elapsed will become deteriorated and can no longer maintain its original performance.

4

How to Use

4-1. Before using the detector

Not only the first-time users but also the users who have already used the detector must follow the operating precautions.

Ignoring the precautions may damage the detector, resulting in inaccurate gas detection.

4-2. Preparation for start-up

Check the following points before starting gas detection.

- The battery level is sufficient.
- The filter in the detector is not contaminated or clogged.
- The display or other parts are not damaged.

Attaching batteries

When the detector is used for the first time, or when the battery level is low, install or replace with the new AA alkaline dry batteries according to the following procedure.



CAUTION

- Turn off the power of the detector before replacing the batteries.
- Perform battery replacement in a non-hazardous area where no explosive gases exist.
- Replace all of the four batteries with new ones at one time.
- Pay attention to the polarities of the batteries when installing them.
- Completely lock the battery cover after installing the batteries. If the battery cover is not completely locked, the dry batteries may drop off.
- Do not use rechargeable batteries that may interrupt a measurement due to the discharge characteristic of rechargeable batteries.

- 1 Check that the power of the main unit is turned off.**
If the power is turned on, press the **ON/OFF/START** button to turn it off.
- 2 Unlock the battery cover by pulling the lock plate open and open the battery cover.**

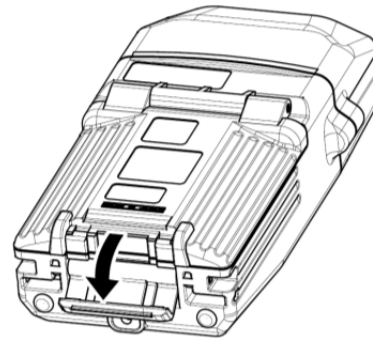

- 3 Paying attention to the polarities of the batteries, install new batteries.**
Remove any old batteries from the case.



- 4 Close the battery cover and then close the lock plate.**
Close the lock plate tightly until it clicks.

4-3. How to start the detector

When the power is turned on, a self-diagnostic starts, and then the detector enters the waiting condition.

Power-on

Press and hold the **ON/OFF/START** button (one second or longer) until the buzzer blips to turn on the power.

NOTE

- When the button is pressed, the buzzer emits a blip to indicate an effective operation but does not if the operation is ineffective or the processing overflows.

Basic operating procedures

When the power is turned on, the LCD display changes automatically as shown below, and the detector enters the waiting condition.

<When No Detection TAB is Mounted>

- 1 **Press and hold the **ON/OFF/START** button for one second or longer.**

After all LCD displays light up, the date and time is displayed.

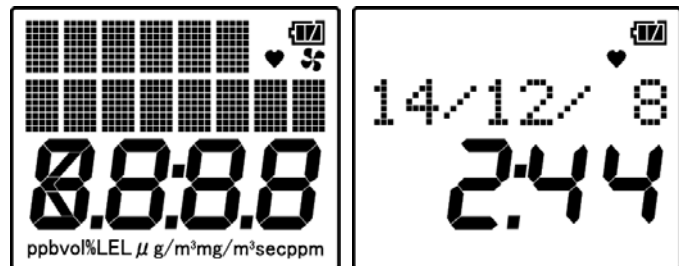

The capacity of the batteries is displayed for about five seconds.

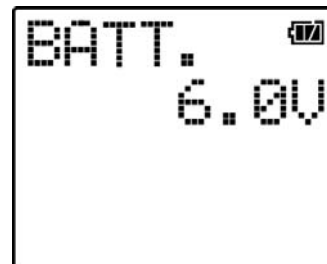

The message of "STAND BY" is displayed for about five seconds.



- 2 Mount the detection TAB on the detector.



- 3 Select a detection TAB using the  or  button.

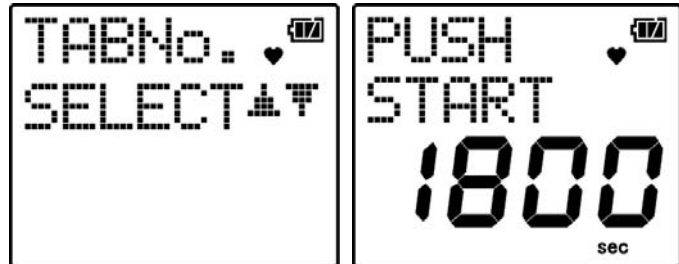

<When Detection TAB is Mounted>

- 1 Press and hold the **ON/OFF/START** button for one second or longer.

After all LCD displays light up, the date and time is displayed.

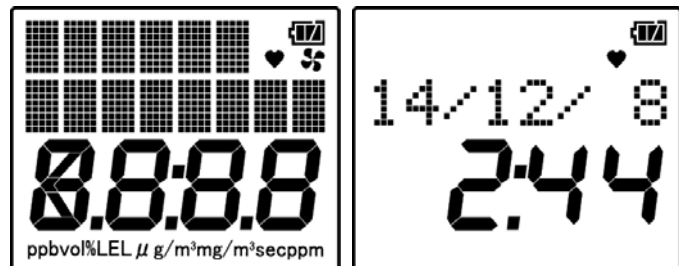

The capacity of the batteries is displayed for about five seconds.



The message of "SELF CHECK" is displayed for about five seconds.



The message of "STAND BY" is displayed for about five seconds.

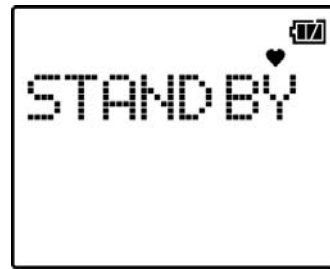

- 2 Select a detection TAB using the ▲ or ▼ button.



CAUTION

- Do not dismount the detection TAB during self-diagnostic. Dismounting of the detection TAB during self-diagnostic will disturb accurate self-diagnostic, and the message of "FAIL" is displayed on the display.

NOTE

- When the power is turned on with a detection TAB mounted, self-diagnostic will start to check the optical sensor. Perform a sensor check as needed.
- Use a new detection TAB for self-diagnostic, if possible. If a severely deteriorated detection TAB such as a detection TAB that is once used or left for a long time after opening the bag is used, this may impair correct sensor check, and the message of "FAIL" may be displayed.

4-4. Mounting of detection TAB

The mounting of detection TAB is required to perform gas detection using the detector. For handling of detection TAB, see "[3-3. Detection TAB](#)" on page 12.

- 1 Pull up the detection TAB cover to open.**

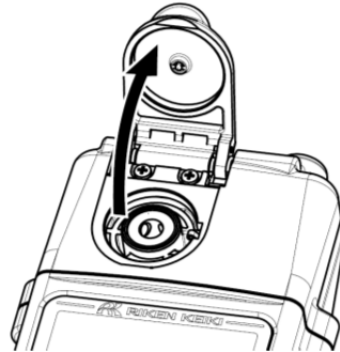

- 2 Set the detection TAB on the mounting opening.**
Pay attention to the front and back of the detection TAB when mounting it.



- 3 Close the detection TAB cover and push the center part firmly with fingers.**



CAUTION

- After placing the detection TAB on the mounting opening, close the detection TAB cover gently. Closing the cover quickly may cause a malfunction.
- Close the detection TAB cover gently to prevent fingers from being pinched. Be careful not to release the fingers holding the cover suddenly. This may cause damage to the cover or an unexpected injury.
- Be careful not to enter water drops, dust, etc. from the mounting opening when mounting the detection TAB.
- Mount the detection TAB on the detector immediately after the bag is opened and start gas detection to maintain the original performance of the detector. After the bag is opened, the detection detection TAB is affected by the gas to be detected, other interference gases which react with other reagents to give a color and dust.
- Mount the detection TAB correctly. If the detection TAB is incorrectly mounted on the detector, the detector cannot deliver its original performance.
- Check that the number of the detection TAB mounted on the detector agrees with the number selected on the detector before starting detection. If the two numbers are not the same, the detector cannot deliver its original performance due to the difference in measurement time.

4-5. How to detect

Gas concentration detection starts from the Waiting Condition. Once gas concentration detection is started, the detector draws in gas to be detected for a certain period of time and then displays the gas concentration.

Gas concentration detection

Perform gas concentration detection following the procedure below.

- 1 Mount the detection TAB in the waiting condition.**
See "4-4. Mounting of detection TAB" on page 18.

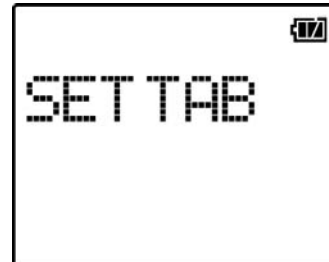

- 2 Select a detection TAB using the ▲ or ▼ button.**



- 3 Press the ON/OFF/START button.**



The countdown of detection time (second) is displayed.



After the countdown is completed, the detected concentration is displayed.

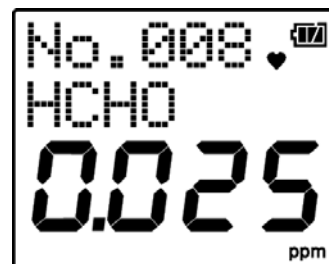

The number stored in the memory is displayed.



After completion of the detection, a message indicating the completion of detection and a concentration are alternately displayed.



4 Dismount the detection TAB.

NOTE

- Only one type of detection TAB is used with the detector, but there are two types of measurement ranges available. Select a TAB No. according to the measurement range.
Measurement range 0 to 0.4 ppm, Measurement time 1800 seconds (30 minutes): TAB No. 008
Measurement range 0 to 1 ppm, Measurement time 900 seconds (15 minutes): TAB No. 009



DANGER

- The gas drawn in may be oxygen-deficient or toxic gas. Never inhale the gas exhausted from the gas outlet.
If the gas drawn in may be oxygen-deficient or toxic gas, discharge it to a place that is deemed safe.



CAUTION

- Do not block the gas inlet and outlet during gas concentration detection. This prevents accurate detection.
- If the temperature changes by 5°C or more during gas concentration detection, the protection function is triggered, automatically stopping the detection.
- Do not dismount the detection TAB during gas concentration detection. If the detection TAB is dismounted, the detection will be interrupted. After the message of "TAB REPLACE" is displayed, mount a new detection TAB and retry detection.
- Never fail to use a new detection TAB for gas detection. If a detection TAB that is once used or left for a long time after opening the bag is used, this may impair accurate detection, and the message of "TAB FAILURE" may be displayed. Even if the "TAB FAILURE" message is not displayed, the detection result is not accurate.
The use of a detection TAB that is new but affected by gases in the atmosphere may affect the performance of the detector.
- Do not use used detection TAB. The detection TAB can be used for single gas detection. Even if the detection result shows less than 0.01 ppm, the second detection with the same detection TAB will not produce an accurate result.



CAUTION

- If the detection place is changed, for example after detecting a high concentration gas, the gas remaining in the detector may influence the next detection. In such cases, perform preliminary sample drawing or purge to discharge the remaining gas from the detector. See "4-6. Preliminary sample drawing" on page 24 and "4-7. Purge" on page 25.
- Do not let the detector draw in water or oil. The internal pump or sensor may become inoperative.
- Check the drawing operation of the pump before detection.
This can be checked by the operating noise of the pump or the drawing condition of the pump's inlet. The detection is disabled while the pump is stopped.

NOTE

- The drawing time varies depending on the type of detection TAB.
- When the detection result is less than 0.015 ppm, the detector displays "<0.01" on it.

High concentration gas detection

If the detection of a high concentration gas is performed after a new detection TAB is mounted, the high concentration gas accumulated reacts with the detection TAB, and then the detector starts gas detection automatically. In this case, the previously selected measurement range is used for the gas detection.

Check of detection results

The past detection results can be displayed in the detection standby or detection completion state. Up to 99 of detection results can be stored in the memory. The measurement results are maintained even after the detector is turned off.

- 1 Press the **DATA** button in the detection standby or detection completion state.

The last detection result is displayed.

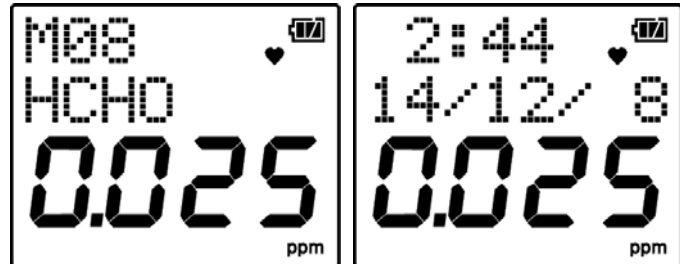

If gas detection is never done or the detection results are deleted, the right message is displayed.

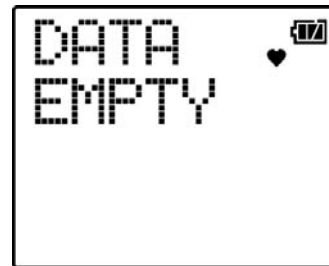

If the number of detection results exceeds 99, the right message is displayed. Delete the detection results to store a new one. See the next section "[Deletion of detection results](#)" on page 23.



- 2 Select a past detection result using the **▲** or **▼** button.

- 3 Press the **DATA** button.

The detector returns to the detection standby or detection completion state.

If no button operation is done on the detector for 20 seconds or longer, the display will automatically return to waiting condition or the gas concentration display in the detection completion state.

Deletion of detection results

All of the past detection results can be deleted while being checked.

- 1 **During the check of detection results, press the **ON/OFF/START** and **DATA** buttons at the same time.**

A confirmation message for the deletion of detection results is displayed.

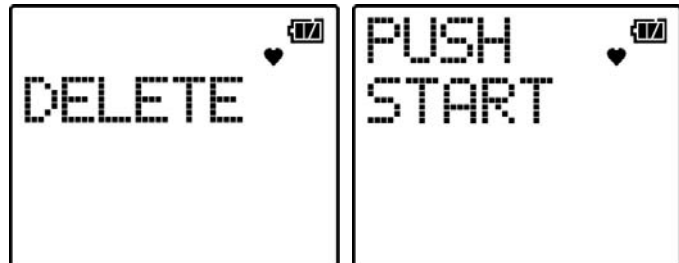

- 2 **Press the **ON/OFF/START** button.**

All detection results will be deleted.

To cancel the deletion, press the **DATA** button after the step 1.

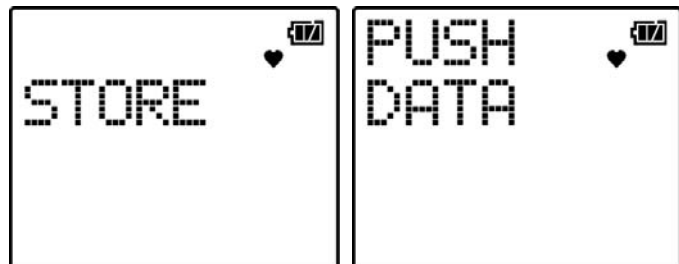

NOTE

- The detection results cannot be deleted one by one.
- The deletion operation deletes all detection results at once. Perform this operation with extreme care because the detection results that were once deleted cannot be recovered.

4-6. Preliminary sample drawing

After the detection of a high concentration gas or similar cases, the gas remaining in the detector may influence the next detection. Perform preliminary sample drawing to discharge remaining gas completely from the detector.

- 1 **Dismount the detection TAB.**
- 2 **Press the ON/OFF/START button.**

Preliminary sample drawing is performed for about five seconds.



CAUTION

- Preliminary sample drawing must be performed under a fresh atmosphere.

NOTE

- Perform preliminary sample drawing as needed.

4-7. Purge

When gas detection is continuously conducted, the gas adsorbed in the tubing may prevent accurate gas detection (readings become slightly higher than the actual concentration). Never fail to purge the gases adsorbed in the tubing with atmospheric air (no gas to be detected is contained) before starting gas detection.

1 **Mount a used detection TAB.**

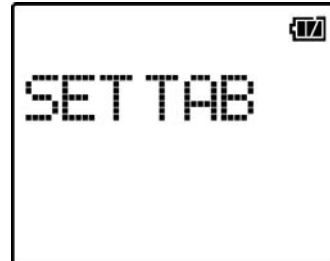

2 **Select purge using the ▲ or ▼ button.**



3 **Press the ON/OFF/START button.**

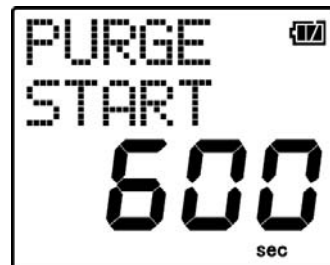

Purge starts, and the countdown of 600 seconds (ten minutes) is displayed.
After a lapse of 600 seconds (ten minutes), purge will automatically end.

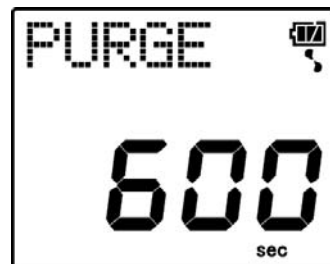

4 **Dismount the detection TAB.**



4-8. Change in date and time

The date and time of the internal clock can be changed. Set year -> month -> day -> hour -> minute in this order.

- 1 Press and hold the **DATA** button on the screen for TAB selection for three seconds or longer.



After the memory screen is displayed, the date and time are displayed.

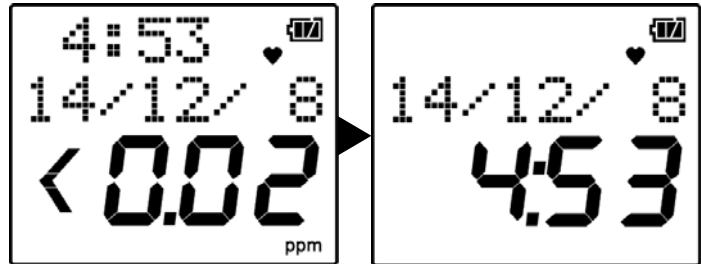

- 2 Press the **▼** and **DATA** buttons at the same time.
The year display blinks.
•Using the **▲** or **▼** button, the numbers displayed can be changed.

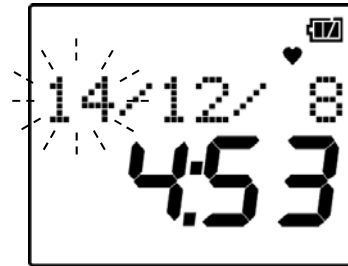

- 3 After setting the year, press the **ON/OFF/START** button.
The month display blinks.
•Using the **▲** or **▼** button, the numbers displayed can be changed.
•Continue to make the settings of day, hour and minute in a similar procedure; Press the **ON/OFF/START** button to move to the next setting.
•Press the **DATA** button to return the previous setting, e.g. month -> year.

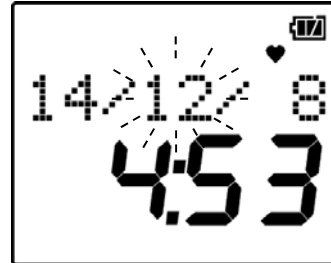

- 4 After setting the minute, press the **ON/OFF/START** button.
"END" is displayed, and then the date and time that have just been set are displayed.

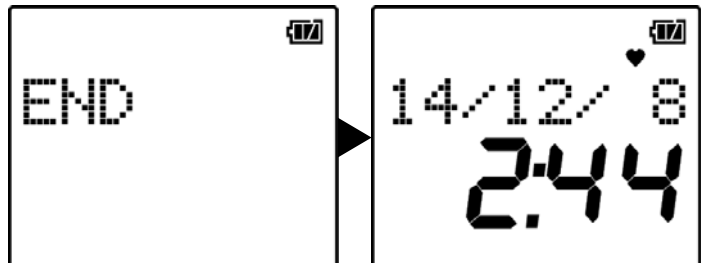

- 5 Press the **DATA** button.
The screen will return to the TAB No. SELECT screen.

NOTE

- If the detector mistakenly enters another mode, turn off the power and try again.
- In the event of a failure of the internal clock, promptly contact RIKEN KEIKI.

4-9. Power-off

Press and hold the **ON/OFF/START** button (three seconds or longer) until the buzzer sounds nine blips to turn off the power.

NOTE

- To turn off the power, keep the button pressed until the display disappears.
- If no operation is done on the detector five minutes or longer after power-on or the completion of measurement, the power will be automatically turned off.



CAUTION

- When the detector is contaminated, clean it with a dustcloth, etc. after wetting it in water and wringing it out well.
- When cleaning the detector, do not use organic solvents such as alcohol and benzene on it.

5

Self-diagnostic

The detector has the types of self-diagnostic functions shown in the table below.
Each alarm is notified by buzzer and display.

<Self-Diagnostic Type and Alarm Pattern>

Symptoms	Buzzer	Display
At power-on		
Battery voltage low	Continuous	CHANGE BATTERY
Detector system error	None	SYSTEM ERROR
Sensor failure	Continuous	FAIL
During detection		
Advance notice of battery voltage low	None	Indicated by battery icon
Battery voltage low	Continuous	CHANGE BATTERY
Poor pump connection	Continuous	PUMP FAILURE
Dismounting of detection TAB	None	TAB REPLACE
Defective detection TAB	Continuous	TAB FAILURE ↓↑ REMOVE TAB
Abnormal temperature	Continuous	TEMP. FAILURE

6

Maintenance

The detector is an important instrument for the purpose of safety. To maintain the performance of the detector and improve the reliability of safety, perform a regular maintenance.

6-1. Maintenance intervals and items

This is a safety unit. Never fail to perform daily and regular maintenance before use.

- Daily maintenance: Perform maintenance before commencing each work.
- Regular maintenance: Perform maintenance at least once a year to maintain the performance as a safety unit.

Maintenance item	Maintenance content	Daily maintenance	Regular maintenance
Battery level	Check that the battery level is sufficient.	○	○
Filter	Check that the filter is not contaminated.	○	○
Operation of main unit	Check the LCD display for a fault indication.	○	○
Concentration display	Make the detector draw in fresh air and check that the concentration display value is zero. When the value is other than zero, perform zero calibration after ensuring that no other gases exist around the detector.	○	○



WARNING

- If an abnormality is found in the detector, contact RIKEN KEIKI immediately.

NOTE

- The built-in sensor of the detector has a validity period and must be replaced regularly.

6-2. How to clean

Clean the detector if it becomes extremely dirty. The detector must be turned off while cleaning it. Use a waste cloth or the like to remove dust. Do not use water or organic solvent for cleaning because they may cause malfunctions.



CAUTION

- When cleaning the detector, do not splash water over it or use organic solvents such as alcohol and benzene on it. Otherwise, it may cause discoloration or damage to the surface of the detector or a sensor failure.

6-3. Consumables

Consumables used for the detector include regular replacement parts and batteries. Replace the consumables at recommended maintenance intervals.

<List of Recommended Regular Replacement Parts>

	Name	Recommended maintenance interval	Recommended replacement interval	Quantity (pieces per unit)	Remarks
1	Pump unit	6 months	1 - 2 years	1	RP-12*
2	Filter	6 months	6 months - 1 year	1	*
3	Alkaline dry battery	—	—	4	

* The operation must be checked after replacement by a qualified service engineer. For the stable operation of the detector and safety, ask a qualified service engineer to take care of replacement of the parts. Request RIKEN KEIKI for operation check.

NOTE

- The above replacement intervals are recommendation only. The intervals may change depending on the operating conditions. These intervals do not mean the warranty periods either. The result of the regular maintenance may determine when to replace the parts.

<Battery Replacement>

For battery replacement procedure, see "[4-2. Preparation for start-up](#)" on page 13.

7

Storage and Disposal

7-1. Procedures to store the detector or leave it for a long time

The detector must be stored under the following environmental conditions.

- In a dark place under the normal temperature and humidity away from direct sunlight
- In a place where gases, solvents or vapors, etc. are not present

Store the detector in a shipping carton, if any, in which the product was delivered.

Store the detector away from dust, etc. if the shipping carton is not available.



CAUTION

- If the detector is not used for a long time, store it after removing the batteries. Battery leaks may result in fire, injury, etc.
- If the detector is not used for a long time, turn on the power at least once every six months and check that the pump draws in air (about three minutes). The detector, when not activated for a long time, may cease to work because of hardening of the grease in the pump motor.

7-2. Procedures to use the detector again

When the detector is used again after a long-period storage, perform a calibration.



CAUTION

- Contact RIKEN KEIKI for information on readjustment including calibration.

7-3. Disposal of products

When the detector is disposed of, it must be treated properly as an industrial waste (noncombustibles) in accordance with the local regulations, etc.



WARNING

- Dispose of batteries in accordance with a procedure specified by the local authority.

8

Troubleshooting

The Troubleshooting does not explain the causes of all the malfunctions which occur on the detector. This simply helps to find the causes of malfunctions which frequently occur.

If the detector shows a symptom which is not explained in this manual, or still has malfunctions even though remedial actions are taken, please contact RIKEN KEIKI.

Symptoms (Message)	Causes	Actions
Battery voltage low (CHANGE BATTERY)	The battery voltage is getting low.	Replace all the four batteries with new ones. See " 4-2. Preparation for start-up " on page 13.
Sensor failure (FAIL)	An excessive shock was given to the detector, e.g. falling or hitting against something, or the detector was used for a long time.	After cycling the power, perform a sensor check (self-diagnostic). If the symptom persists, consult RIKEN KEIKI.
	The detection TAB was dismantled during sensor check (self-diagnostic).	After mounting the detection TAB and cycling the power, retry the sensor check (self-diagnostic).
Poor pump connection (PUMP FAILURE)	An excessive shock was given to the detector, e.g. falling or hitting against something, or the detector was used for a long time.	After cycling the power, perform a sensor check (self-diagnostic). If the symptom persists, consult RIKEN KEIKI.
Detector system error (SYSTEM ERROR)	The detector was affected by too much noise.	Cycle the power. If the symptom persists, consult RIKEN KEIKI.
Dismounting of detection TAB (TAB REPLACE)	The detection TAB was dismantled during gas detection.	Mount the detection TAB and then dismount it after completion of the gas detection.
Defective detection TAB (TAB FAILURE) ↓↑ (REMOVE TAB)	The initial condition of the detection TAB is not normal.	Replace the detection TAB with a new one. See " 4-4. Mounting of detection TAB " on page 18.
Abnormal temperature (TEMP. FAILURE)	The ambient temperature of the main unit changed rapidly.	After confirming that the atmospheric temperature remains constant, leave the detector under the atmosphere for 30 minutes or more before measurement.
The power cannot be turned on.	The power is not turned on. The battery level is too low.	Replace all the four batteries with new ones. See " 4-2. Preparation for start-up " on page 13.
	The ON/OFF/START button was released quickly.	To turn on the power, press and hold the ON/OFF/START button until a beep is heard.
	The polarities of the batteries are wrong.	Check that the batteries are properly installed in the main unit. See " 4-2. Preparation for start-up " on page 13.

Symptoms (Message)	Causes	Actions
The pump does not work.	The capacity of the batteries used is getting low.	After replacing all the four batteries with new ones, cycle the power. See " 4-2. Preparation for start-up " on page 13.
Gas cannot be drawn in.	The sampling hose is disconnected, or the tubing is clogged.	Check the sampling hose and tubing for connections, clogging, etc.

Product Specifications

Model	FP-31
Gas to be detected	Formaldehyde (HCHO)
Detection Principle	Photoelectric photometry method
Measurement range	TAB 008: 0.000 - 0.400 ppm (" <0.01 " is displayed for less than 0.015 ppm.) TAB 009: 0.00 - 1.00 ppm (" <0.02 " is displayed for less than 0.02 ppm.)
Measurement time	TAB 008: 1800 seconds (30 minutes) TAB 009: 900 seconds (15 minutes)
Fault alarm Self-diagnosis	Battery voltage low, Sensor failure, Poor pump connection, Detector system error, Abnormal temperature
Detection method	Pump drawing type/Time accumulations measurement
Display method	LCD digital display
Memory function	Up to 99 detection points (Automatic recording after detection)
Use temperature/humidity range	Operating temperature range: $-10 - +40^{\circ}\text{C}$ Operating humidity range: 90%RH or less (Non-condensing) *The operating temperature and humidity ranges of each detection TAB are indicated on the detection TAB itself.
Power supply	AA alkaline dry battery x 4
Continuous operating time	About 12 hours (new dry batteries, without alarms or lighting, at 20°C)
Outer dimensions	Approx. 80 (W) x 150 (H) x 40 (D) mm (Only main unit excluding projections)
Weight	About 250 g (without dry batteries)
Functions	Data logger function, Clock function

10

Appendix

10-1. Detection principle

By introducing gas to the detection TAB, the special test paper impregnated with color former that has been incorporated into the detection TAB exhibits a color by a chemical reaction.

For example, if formaldehyde (HCHO) contacts with the test paper of the detection TAB, a compound is formed by a chemical reaction of the color former contained in the paper and HCHO, changing the paper color from white to yellow.

The degree of the color forming is recognized as change in the amount of reflection light. The change ratio of this reflection light intensity is called a response value to a gas concentration. With a standard curve obtained in advance, a concentration can be determined from a response value of the gas to be detected.

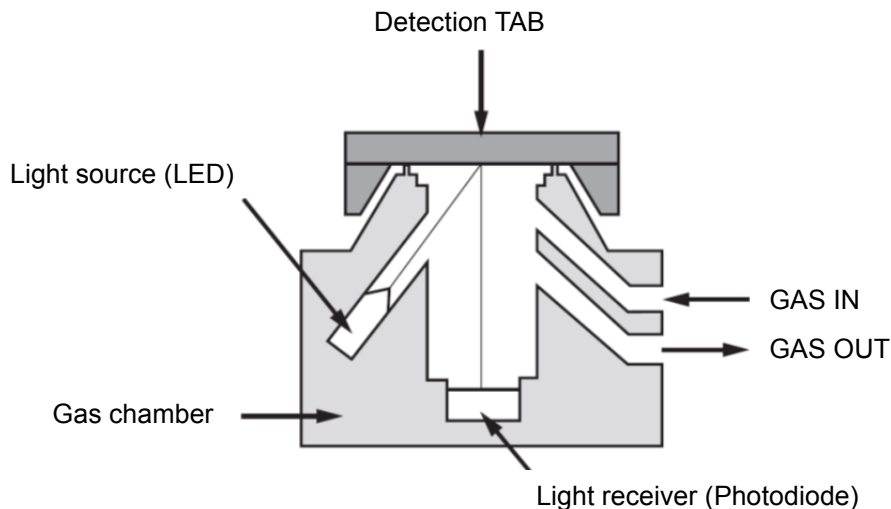

Declaration of Conformity

We, **RIKEN KEIKI CO., LTD.**

**2-7-6, Azusawa, Itabashi-ku,
Tokyo 174-8744 Japan**

declare in our sole responsibility that the following product conforms to all the relevant provisions.

Product Name: HCHO Gas Detector

Model Name: FP-31

Council Directives: EMC: 2004/108/EC(Until 19 April 2016)
2014/30/EU(From 20 April 2016)
RoHS:2011/65/EU

Applicable Standards: EMC: EN50270:2015 (Type2)
RoHS:EN50581 (2012)

Year to begin affixing CE Marking: 2016

Place: Tokyo, Japan

Signature: *Tetsuya Kawabe*

Full Name: Tetsuya Kawabe

Date: Mar 31,2016

Title: Director, Quality control center