



**Personal Oxygen Gas Monitor  
OX-03  
Operating Manual**

**RIKEN KEIKI Co., Ltd.**

2-7-6 Azusawa, Itabashi-ku, Tokyo, 174-8744, Japan

Phone : +81-3-3966-1113

Fax : +81-3-3558-9110

E-mail : [intdept@rikenkeiki.co.jp](mailto:intdept@rikenkeiki.co.jp)

Web site : <http://www.rikenkeiki.co.jp/>

# Safety information

The Personal Gas Monitor Model 03 series (GP-03, OX-03, CO-03, HS-03) are a gas monitor designed to provide continuous exposure monitoring of combustible gas (GP-03), Oxygen (OX-03) or toxic gas (CO-03 and HS-03) in hazardous location.

GP-03: combustible gas monitor  
OX-03: oxygen monitor  
CO-03, HS-03: toxic gas monitor

## Specification for safety

- Ex ia IIC T4/T3 Ga
- Ex ia I Ma
-  II 1G Ex ia IIC T4/T3 Ga  
I M1 Ex ia I Ma
- Ambient temperature range : -20°C to +50°C

## Electrical data

- T4: Powered by two series AAA size alkaline batteries, model LR03 by TOSHIBA.
- T3: Powered by two series AAA size Ni-MH batteries, model eneloop by PANASONIC.

## Certificate numbers

- IECEx Certificate number : IECEx DEK 13.0092
- ATEX Certificate number : DEKRA 13 ATEX 0229

## List of standards

- |                     |                   |
|---------------------|-------------------|
| • IEC 60079-0:2011  | • EN60079-0:2012  |
| • IEC 60079-11:2011 | • EN60079-11:2012 |
| • IEC 60079-26:2006 | • EN60079-26:2007 |
|                     | • EN50303:2000    |

## WARNING

- Do not replace batteries in hazardous location.
- Do not attempt to disassemble or alter the instrument.
- Use only with two series connected Alkaline AAA batteries, type LR03 manufactured by Toshiba, or use two series connected rechargeable battery type eneloop manufactured by Panasonic.
- T4: type LR03 manufactured by Toshiba, T3: type eneloop manufactured by Panasonic.

INST. No. 0 0 0 0 0 0 0 0 0 0 0 0  
                  A B C       D    E

A: Manufacturing year (0-9)

B: Manufacturing month  
(1-9, XYZ for Oct.-Dec.)

C: Manufacturing lot

D: Serial number

E: Code of factory



**RIKEN KEIKI Co., Ltd.**  
2-7-6 Azusawa, Itabashi-ku, Tokyo, 174-8744, Japan

Phone : +81-3-3966-1113

Fax : +81-3-3558-9110 GIII

E-mail : [intdept@rikenkeiki.co.jp](mailto:intdept@rikenkeiki.co.jp)

Web site : <http://www.rikenkeiki.co.jp>

# <Contents>

1. Outline of the Product .....	3	4-4. How to detect.....	14
1-1. Preface .....	3	4-5. Seeing information.....	15
1-2. Purpose of use .....	3	5. Operations and Functions .....	17
1-3. Definition of DANGER, WARNING, CAUTION, and NOTE .....	4	5-1. Gas alarm activation .....	17
2. Important Notices on Safety .....	5	5-2. Fault alarm activation .....	19
2-1. Danger cases .....	5	5-3. Data logger function .....	19
2-2. Warning cases .....	5	6. Maintenance.....	20
2-3. Precautions .....	6	6-1. Maintenance intervals and items ....	20
3. Product Components .....	8	6-2. User mode .....	22
3-1. Checking the package .....	8	6-3. How to clean.....	27
3-2. Names and functions for each part ...	9	6-4. List of recommended regular replacement parts.....	27
4. How to Use .....	11	6-5. Filter replacement.....	28
4-1. Preparation for start-up .....	11	7. Storage and Disposal .....	29
4-2. Power-on and power-off .....	12	7-1. Procedures to store the gas monitor or leave it for a long time .....	29
4-3. Performing air calibration.....	13		

7-2. Procedures to use the gas monitor again .....	29
7-3. Disposal of products .....	30
8. Troubleshooting .....	32
9. Product Specifications .....	33

## Outline of the Product

### 1-1. Preface

Thank you for choosing our personal oxygen gas monitor OX-03 (hereinafter referred to as the gas monitor). Please check that the model number of the product you purchased is included in the specifications on this manual.

This manual explains how to use the gas monitor and its specifications. It contains information required for using the gas monitor properly. Not only the first-time users but also the users who have already used the product must read and understand the operating manual to enhance the knowledge and experience before using the monitor.



### 1-2. Purpose of use

This product is a single gas monitor used to detect oxygen in the air.

Detection results are not intended to guarantee life or safety in any way.

## 1-3. Definition of DANGER, WARNING, CAUTION, and NOTE

Throughout this manual, the following indications are used to ensure safe and effective work.

 <b>DANGER</b>	This message indicates that improper handling may cause serious damage on life, health or assets.
 <b>WARNING</b>	This message indicates that improper handling may cause serious damage on health or assets.
 <b>CAUTION</b>	This message indicates that improper handling may cause minor damage on health or assets.
<b>NOTE</b>	This message indicates advice on handling.

## Important Notices on Safety

### 2-1. Danger cases



#### DANGER

##### About explosion-proof

- Do not modify or change the circuit or structure, etc.
- When measuring the oxygen concentration, do not measure anything but a mixture of air and combustible gases or vapors and toxic gases.
- When using the gas monitor in a hazardous area, take the following countermeasures for preventing dangers resulting from electrostatic charges.
  - (1) Wear anti-static clothes and conductive shoes (anti-static work shoes).
  - (2) For indoor use, use the gas monitor while standing on a conductive work floor (with a leakage resistance of 10 MΩ or less).
- The gas monitor has a different explosion-proof class depending on the battery type. Because it has a different certificate number too, check the battery number against the certification plate number before use.
- Replace the batteries in a non-hazardous area.
- Use only the batteries specified by RIKEN KEIKI on this gas monitor.

### 2-2. Warning cases



#### WARNING

##### Fresh air adjustment in the atmosphere

- When the fresh air adjustment is performed in the atmosphere, check the atmosphere for freshness before beginning the adjustment. If other gases exist, the adjustment cannot be performed properly, thus leading to dangers when the gas leaks.

##### Battery level check

- Before use, check that there remains sufficient battery power. When the gas monitor is not used for a long period, the batteries may be exhausted. Replace them with new ones before use.
- If a low battery voltage alarm is triggered, gas detection cannot be conducted. If the alarm is triggered during use, turn off the power and promptly replace the batteries.



## WARNING

### Others

- Do not throw the gas monitor into fire.
- Do not wash the gas monitor in a washing machine or ultrasonic cleaner.
- Do not block the buzzer sound hole. No alarm sound can be heard.

## 2-3. Precautions



## CAUTION

Do not use the gas monitor where it is exposed to oil, chemicals, etc. Do not submerge the gas monitor under water on purpose.

- Do not use in a place where the gas monitor is exposed to liquids such as oil and chemicals.
- The gas monitor, being compliant to IP67, is not water-pressure-resistant. Do not use the gas monitor where a high water pressure is applied to it (under a faucet, shower, etc.) or submerge it under water for a long time. The gas monitor is water-proof only in fresh water and running water, and not in hot water, salt water, detergent, chemicals, human sweat, etc.



## CAUTION

- Do not place the gas monitor where water or dirt gets accumulated. The gas monitor placed at such a location may cause malfunction due to water or dirt that gets into the buzzer opening.

Do not use the gas monitor in a place where the temperature drops below  $-20^{\circ}\text{C}$  or rises over  $50^{\circ}\text{C}$ .

- The operating temperature of the gas monitor is  $-20$  to  $50^{\circ}\text{C}$ . Do not use the gas monitor at higher temperatures, humidities, and pressures or at lower temperatures than the operating range.
- Avoid long-term use of the gas monitor in a place where it is exposed to direct sunlight.
- Do not store the gas monitor in a sun-heated car.

Do not use a transceiver near the gas monitor.

- Radio wave from a transceiver near the gas monitor may disturb readings. If a transceiver is used, it must be used in a place where it disturbs nothing.
- Do not use the gas monitor near a device that emits strong electromagnetic waves (high-frequency or high-voltage devices).

Never fail to perform a regular maintenance.

- Since this is a safety unit, a regular maintenance must be performed to ensure safety. Continuing to use the monitor without performing a maintenance will compromise the sensitivity of the sensor, thus resulting in inaccurate gas detection.





## **CAUTION**

### Others

- Pressing buttons unnecessarily may change the settings, preventing alarms from activating correctly. Operate the gas monitor using only the procedures described in this operating manual.
- Do not drop or give shock to the gas monitor. The water-proof and explosion-proof properties and accuracy may be deteriorated.
- Do not pick the sensor or buzzer opening with a sharp-pointed item. The unit may cause malfunction or get damaged, possibly resulting in incorrect measurements.
- Do not give strong shock or vibration to the gas monitor because it is a precision device.

## **Product Components**

### **3-1. Checking the package**

After unpacking, be sure to check that all the accessories are included in the package.

- OX-03 (the main unit)
- Rubber protection cover (pre-attached to the main unit)
- Alligator clip (pre-attached to the main unit)
- Batteries (pre-installed in the main unit)
- Operating manual (this document)

## 3-2. Names and functions for each part

### <Appearance>

- Alarm lamp  
\* Blinks (red) at an alarm state.
- Buzzer sound opening  
\* Sounds intermittent beeps during switch operation or at an alarm state.
- Gas name indication  
\* Indicates a gas to be detected by the gas monitor.
- AIR button  
\* Used to perform air calibration and operate in modes.



### Communication port

- \* Used for the data logger function. For details, see "5-3. About data logger function".

### Sensor part

- \* Has a gas sensor at the far end of the dust filter.

### Display (LCD)

- \* Displays the gas concentration and other information.

### POWER/MODE button

- \* Used to turn on and off the power and enter modes.

### Rubber protection cover

- \* Protects the main unit.

## <Appearance>

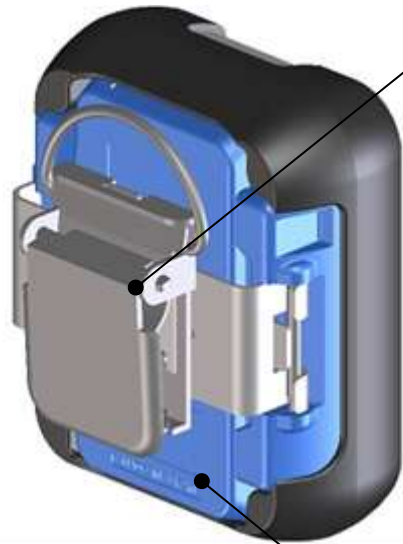

### Alligator clip

\* Used to attach the gas monitor to the top of the pocket.

### Battery cover

\* Can be removed by loosening the fixing screw.

## <Display>

### Gas name and information indication

\* Indicates a gas to be detected by the gas monitor and information such as modes.

### Operation display

\* Blinks the heart mark at a normal state.



### Battery level icon

\* Displays the remaining battery power level by the number of marks.

### Gas concentration display

\* Displays the current detection result.

### Information display

\* Displays information in the display mode, etc. It usually displays nothing.

## How to Use

### 4-1. Preparation for start-up

Before use, read and understand the following precautions. Ignoring these precautions may prevent correct operations.

- Check that the batteries are installed.
- Check that the dust filter is free of dust.
- Check that the gas monitor is not damaged.

#### <Installing the batteries>



#### CAUTION

- Turn off the power of the gas monitor before replacing the batteries.
- Replace both of the two batteries with new ones at one time.
- Pay attention to the polarities of the batteries when replacing them.
- Use only the batteries specified by RIKEN KEIKI on this gas monitor.
- Replace the batteries in a non-hazardous area.

- (1) Check that the power is turned off.
- (2) Loosen the battery cover fixing screws and open the cover.
- (3) Remove the old batteries and install the new ones while paying attention to the polarities.
- (4) Close the cover and fasten the fixing screws.

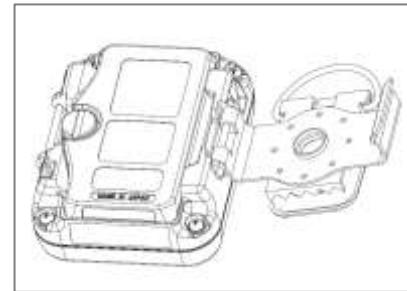

\* Open the clip

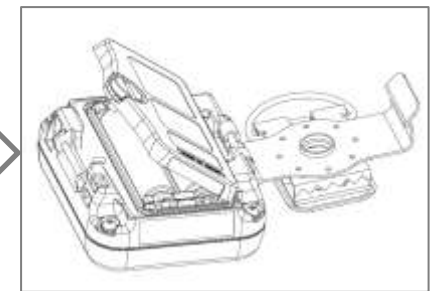

\* Open the battery cover

## 4-2. Power-on and power-off

### <How to power-on>

Press the POWER button until the buzzer blips. After the LCD display switches as follows, the gas monitor enters the detection mode.

All lights ON->Date and time->Battery voltage->Detection range->1st alarm setpoint value->2nd alarm setpoint value->Detection mode (Blip Blip)

### NOTE

- When powering on after leaving the gas monitor for more than five minutes with the batteries removed, such as when powering on for the first time or replacing the batteries, the monitor enters the clock adjustment mode. In this case, see "6-2-1. Time settings" to set the date and time.

### NOTE

- When the communication port of this gas monitor and another gas monitor is in the place of symmetrical, do not turn on the power.  
The status of gas monitor suddenly may move the communication mode "TRANS PC".  
In that case, turn off the power once.  
After that, then turn it on again.  
At that time, so as the each other communication port is not to the place of symmetrical, be careful.

### <How to power-off>

Keep the POWER button pressed until the buzzer blips three times (Blip Blip Blip) from the TURN - OFF display and the LCD turns off.

## 4-3. Performing air calibration



### WARNING

When the air calibration is performed in the atmosphere, check the atmosphere for freshness before beginning the air calibration. If other gases exist, the adjustment cannot be performed properly, thus leading to dangers when the gas leaks.





### CAUTION

- Perform air calibration under pressure and temperature/humidity conditions close to those in the operating environment and in fresh air.
- Perform air calibration after the reading is stabilized.
- If there is a sudden temperature change of 15°C or more between the storage and operation locations, turn on the power of the gas monitor, let it leave for about 10 minutes in a similar environment to the operation location, and perform air calibration in fresh air before using it.

### NOTE

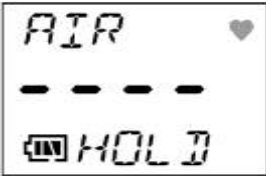
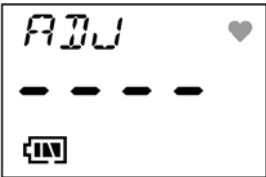
If the air calibration fails, AIR - FAIL is displayed on the LCD. Press the POWER/MODE button to reset the alarm (calibration failure). When the alarm is reset, the value before air calibration is displayed.

Item	LCD	Details
Detection Mode		* Check that the gas monitor is in the detection mode.
AIR - HOLD	↓AIR 	* Keep the AIR button pressed until the LCD display switches from AIR - HOLD (1st buzzer sound, blip) to ADJ (2nd buzzer sound, blip) and then release the button.
ADJ	↓AIR 	
Returns to the detection mode	↓ 	* After adjustment, it automatically returns to the detection mode.

## 4-4. How to detect

After air calibration, attach the gas monitor to the top of the breast pocket with the alligator clip not to hide the sensor. The detection mode is used for normal operations.

The gas monitor consists of the following modes.

### NOTE

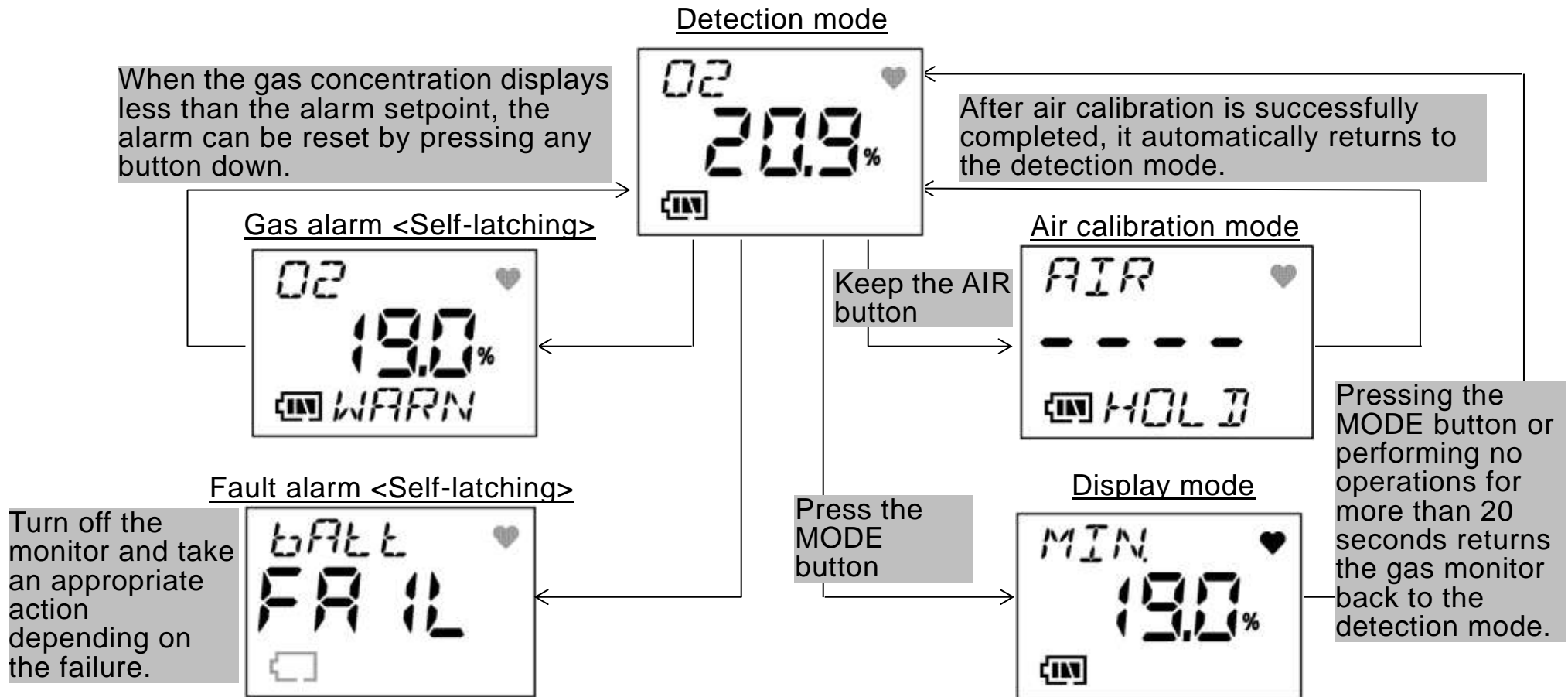

- Open the clip as shown in the right figure and attach it to the top of the breast pocket, etc.
- The clip can be turned by 45 degrees at a time.





## 4-5. Seeing information

Press the MODE button to enter the display mode. Every time the MODE button is pressed, various pieces of information are displayed in turn. The gas detection is running in the background in this mode. If the concentration of detected gas exceeds the alarm setpoint value, the gas monitor automatically returns to the detection mode.

Item	LCD	Details
Detection Mode		
	↓MODE	
MIN Displays minimum value detected from power-on to the present.		* To clear the peak value, press and hold the AIR button until the HOLD display disappears.

**MAX**  
Displays maximum value detected from power-on to the present.

↓MODE



**F.S.**  
Displays the full scale of this monitor.

↓MODE



\* When the monitor displays the full scale, 1st and 2nd alarm setpoint values are displayed alternately every time the AIR button is pressed.

**Date and time**  
Displays the internal clock

↓MODE



↓MODE  
Returns to the detection mode.

**NOTE**

---

- If no switch operations are performed, the monitor automatically returns to the detection mode in about 20 seconds.
  - If no switch operations are performed, the backlight is automatically turned off in about 30 seconds (except at an alarm state).
  - When the gas monitor displays the full scale, hold AIR + MODE buttons down to perform the alarm test.
-

## Operations and Functions

### 5-1. Gas alarm activation

An alarm is triggered when the concentration of the detected gas reaches or exceeds the alarm setpoint value <Self-latching operations>.

#### <Alarm activation>

Alarm type	LCD	Operation
First alarm Setting: 19.5%		Buzzer: Slow intensity change Lamp/Vibration: Slow and intermittent Display: Concentration display blinking Displays WARN

Second alarm  
 Setting: 23.5%



Buzzer: Fast intensity change  
 Lamp/Vibration: Fast and intermittent  
 Display: Concentration display blinking  
 Displays ALRM

Over alarm  
 Setting: 40.0%



Buzzer: Fast intensity change  
 Lamp/Vibration: Fast and intermittent  
 Display: Concentration display blinking  
 Displays OVER

## <How to reset the alarm>

After the concentration of detected gas settles below the alarm setpoint value, press any button to reset the gas alarm.

### NOTE

---

- Even if the concentration of detected gas exceeds the alarm setpoint value, the operations of buzzer, lamp and vibration continue (self-latching) until any button is pressed (the alarm is reset).
-

## 5-2. Fault alarm activation

A fault alarm is triggered when the monitor detects abnormalities <Self-latching operations>.

Determine the causes and take appropriate actions.

If the gas monitor has problems and is repeatedly malfunctioning, contact RIKEN KEIKI immediately.

### <Alarm activation>

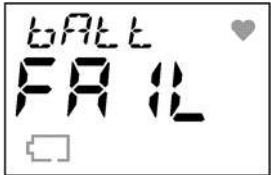
Alarm type	LCD display (example)	Operation
Low battery voltage alarm		Buzzer: Intermittent Lamp: Blinking Vibration: None Display: Concentration display blinking Displays an error message

\* For details on the fault alarm type, primary causes, and appropriate actions, see "8. Troubleshooting".

## 5-3. Data logger function

The gas monitor has a function that records logs of calibration history, trend and event history.

Data logger specifications	Interval trend	1800 data
	(5 hours at 10 second intervals, 150 hours at 5 minute intervals)	
	Alarm trend	1 record (15 minutes before and after at 5 second intervals)
	Alarm event	20 records
	Fault event	20 records
	Calibration history	20 records

The data logger management program (option) is required to use this function. Contact RIKEN KEIKI if it is needed.

\* For details on the operation, see Operating Manual "Data Logger Management Program".

## Maintenance

The gas monitor is an important instrument for the purpose of safety.

To maintain the performance of the gas monitor and improve the reliability of safety, perform a regular maintenance.

Contact RIKEN KEIKI if it is needed.

### 6-1. Maintenance intervals and items

Regular maintenance must be performed at shorter intervals specified either in laws according to your usage environment or by RIKEN KEIKI.

- Daily maintenance: Perform maintenance before beginning to work.
- Monthly maintenance: Perform alarm test once a month.

- Regular maintenance: Perform maintenance once or more every six months to maintain the performance as a safety unit.

Maintenance item	Maintenance content	Daily maintenance	Monthly maintenance	Regular maintenance
Battery level	Check that the battery level is sufficient	○	○	○
Concentration display	Check that the air is fresh and the concentration display value is zero	○	○	○
Filter	Check that the dust filter is free of dust and not damaged	○	○	○

Alarm test	Check that the alarm lamp and buzzer operate normally by using the alarm test function	-	○	○
Span adjustment	Perform the span adjustment by using the calibration gas	-	-	○
Gas alarm	Check that the gas alarm is correctly triggered using the calibration gas	-	-	○

## 6-2. User mode

The user mode is used for maintenance such as setting the time.

Press the POWER button while pressing the AIR button, and release the buttons when the buzzer beeps. The monitor enters the user mode.



### WARNING

After the adjustment is completed, do not forget to return to the detection mode.

(If the gas monitor remains in the regular maintenance mode, it does not automatically return to the detection mode.)



Item	LCD	Details
DATE Date and time settings		See "6-2-1. Time settings"
AIR Air calibration		See "6-2-2. Air calibration"

Item	LCD	Details
A-CAL Auto calibration		See "6-2-3. Auto calibration"
M-CAL Manual calibration		See "6-2-4. Manual calibration"
ROM Displays the program number		* Press the POWER button to display the program number. Confirm the number and then press the POWER button to return to the user menu.
START Starts booting		* Press the POWER button to return to the detection mode after booting.





## 6-2-1. Time settings

Set the date/time of the internal clock.

Item	LCD	Details
DATE		
	↓POWER	
Date and time		* Use the AIR button to change the blinking items and the POWER button to confirm the change. Set Year, Month, Day, Hour, Minute in this order. The clock starts when Minute is confirmed.
	↓	
DATE		* After adjustment, the monitor returns to the user mode menu.



## 6-2-2. Air calibration

Perform air calibration in fresh air.

Item	LCD	Details
AIR		
	↓POWER	
Gas Concentration Display		* Press and hold the AIR button until the LCD display switches from AIR - HOLD (1st buzzer sound, blip) to ADJ (2nd buzzer sound, blip) and then release the button.
	↓	
AIR		* After automatic adjustment, the monitor displays END and then returns to the user mode menu.

### 6-2-3. Auto calibration

This is how to preset the concentration of the prepared span calibration gas to the gas monitor and perform calibration in a single step.

Item	LCD	Details
A-CAL	 ↓POWER	
Adjustment Value Display	 ↓POWER	* Default setting 0.0% * How to change default setting. First, press the AIR +MODE Button. Then, press AIR for to change. Finally, press MODE for to enter.

A-CAL  
(Blinking)



↓POWER

PASS

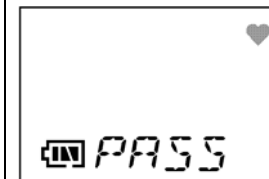

A-CAL



\* Waiting for gas introduction.



\* Starts the gas supply. After 60 seconds, press the POWER button.



\* After automatic adjustment to the preset value, the monitor displays PASS and then returns to the user mode menu.  
 \* If span adjustment is faulty, GAS NAME - FAIL is displayed. Press the MODE button to reset.

\* Stops the gas supply.

## 6-2-4. Manual calibration

This is how to perform calibration with manually set to the concentration value of the prepared span calibration gas.

Item	LCD	Details
M-CAL	 <p>↓POWER</p>  <p>↓AIR + MODE</p>  <p>↓</p>	<p>* Waiting for gas introduction.</p> <p>* Press AIR + MODE to decrease (or to increase) the value.</p>
Concentration Display (Blinking)		

	 <p>↓POWER</p>	<p>* Starts the gas supply. After 60 seconds, press the AIR button to adjust the value and then press the POWER button to confirm it.</p>
END		<p>* After displaying END, the monitor returns to the user mode menu.</p> <p>* If span adjustment is faulty, GAS NAME - FAIL is displayed. Press the MODE button to reset.</p>
	<p>↓</p>	
M-CAL		<p>* Stops the gas supply.</p>

### <Equipment required for gas calibration>

- Span calibration gas N2  
99.9 vol% or more  
(recommended)
- Gas sampling bag
- Polyurethane tube
- Pump with the flow adjustment function  
<adjustable to  $500 \pm 10$  mL/min> (by pump,  
flow meter or valve)

- Stopwatch

- Calibration cap (option) \*1

\*1 Use a dedicated calibration cap (option).

\* The customer is required to provide all except for \*1.

### <Connection between components>

Connect as shown in the figure on the right and adjust the flow.

Attach the gas sampling bag whenever gas introduction is required.

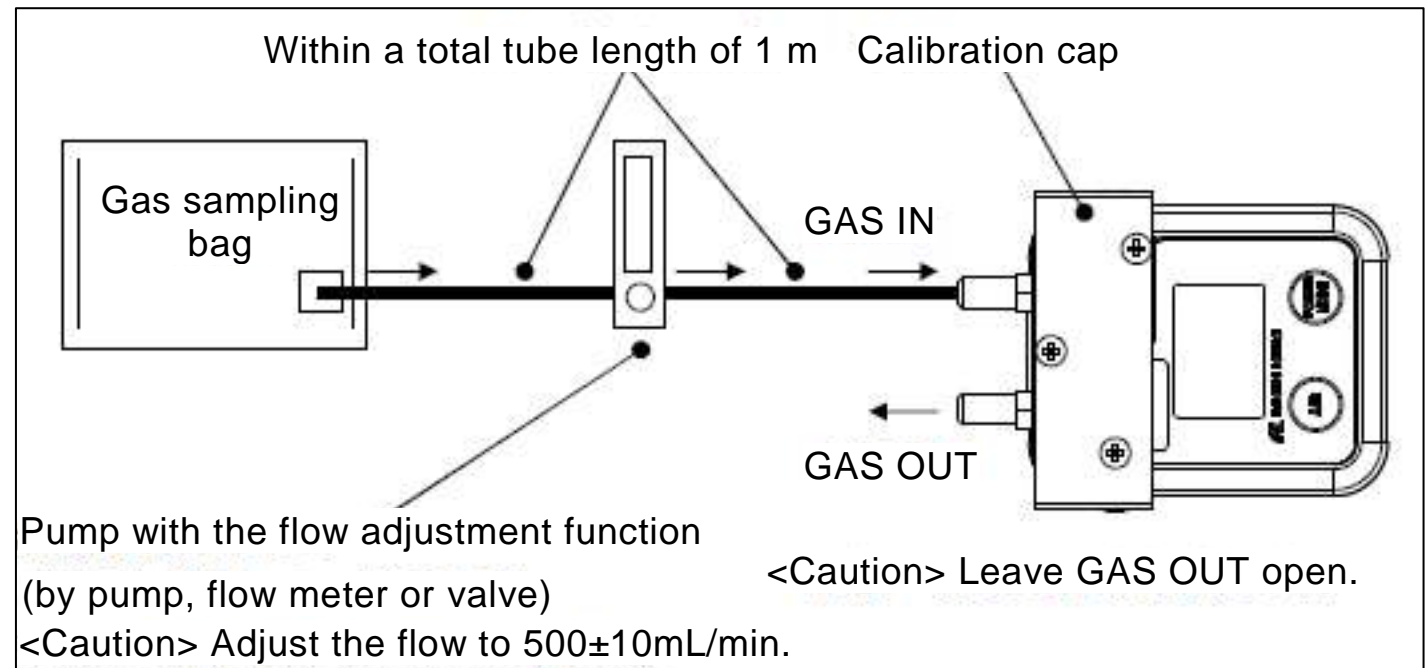

### 6-3. How to clean

Clean the gas monitor if it becomes extremely dirty. The gas monitor must be turned off while cleaning it. Use a waste cloth etc., to remove dust.

Do not use water or organic solvent for cleaning because they may cause malfunctions.

### 6-4. List of recommended regular replacement parts

Name	Maintenance intervals	Replacement intervals	Quantity (pieces per unit)	Remarks
Gas sensor	6 months	1 year	1	*
Rubber seals	-	2 years	1 set	*
Water-proof filter	Before and after use	6 months or when contaminated	1	4123-6394-40

\* The operation must be checked after replacement by a qualified service engineer. For the stable operation of the gas monitor and safety, ask a qualified service engineer to take care of replacement of the parts whose operation must be checked. Request RIKEN KEIKI for operation check.

### NOTE

The replacement intervals are recommendation only. The intervals may change depending on the operating conditions.

These intervals do not mean the warranty periods either.

\*\*\* The result of the daily or regular maintenance may determine when to replace the parts.

## 6-5. Filter replacement

Replace the filter if it is contaminated. Follow the replacement procedure given below.



### CAUTION

Turn off the power of the gas monitor before replacing the filter.

- (1) Check that the power is turned off.
- (2) Remove the rubber protection cover.
- (3) With the display facing downward, remove four screws.

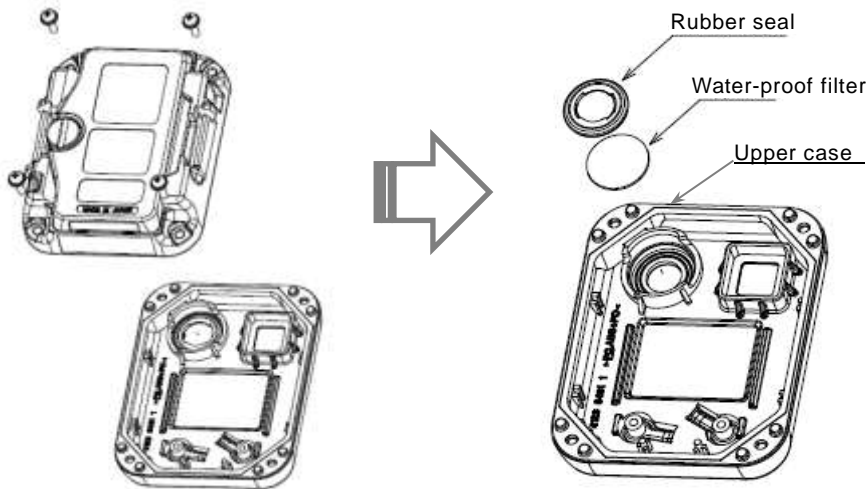

- (4) Open the case.
- (5) Remove the rubber seal and filter referring to the below figure, and replace them with new ones.



### CAUTION

When you are inserting the packing to gas monitor, note the direction. Refer to the figure on the right.

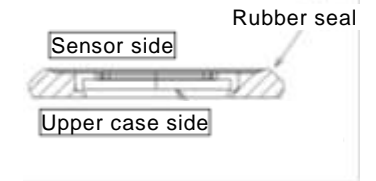

- (6) After replacement, reattach the case and tighten the screws.



### CAUTION

When reattaching the case, be careful not to catch foreign matters by the rubber seal around the case.

- (7) Attach the rubber protection cover.

## Storage and Disposal

### 7-1. Procedures to store the gas monitor or leave it for a long time

The gas monitor must be stored under the following environmental conditions.

- (1) In a dark place under the normal temperature and humidity away from direct sunlight
- (2) In a place where gases, solvents or vapors are not present

Store the gas monitor in a shipping carton, if any, in which the product was delivered.

Store the gas monitor away from dust, etc., if the shipping carton is not available.



#### CAUTION

If the gas monitor is not used for a long time, store it after removing the batteries. Battery leaks may result in fire or injury.

### 7-2. Procedures to use the gas monitor again

When you use a stopped or stored gas monitor again, never fail to perform a gas calibration. For information on readjustment including gas calibration, please contact RIKEN KEIKI.

### **7-3. Disposal of products**

When the gas monitor is disposed of, it must be treated properly as an industrial waste in accordance with the local regulations.

#### <Disposal of Batteries>

- When disposing of the gas monitor in EU member states, sort the batteries as specified. Handle the removed batteries according to the classified refuse collection system and recycling system based on the regulations of EU member states. Contact RIKEN KEIKI to dispose of the gas monitor.



## **Removing batteries**

See Section 4-1 "Preparation for start-up" and take out the batteries.

## **Batteries**

Specifications	Type
Dry battery	Alkaline dry battery
Rechargeable battery	Nickel metal hydride battery

### **NOTE**

- The gas monitor contains batteries.
- Crossed-out recycle dustbin mark



This symbol mark is indicated on the products which contain the batteries which fall under EU Battery Directive 2006/66/EC. Such batteries need to be disposed of as specified by the latest Directive.

This symbol mark indicates that the batteries need to be separated from the ordinary waste and disposed of appropriately.

## Troubleshooting

The troubleshooting does not explain the causes of all the malfunctions which occur on the gas monitor. This simply helps to find the causes of malfunctions which frequently occur.

If the gas monitor shows a symptom which is not explained in this manual, or still has malfunctions even though remedial actions are taken, please contact RIKEN KEIKI.

Symptoms	Causes	Actions
System abnormalities SYSTEM FAIL	A circuit abnormality occurred.	Request RIKEN KEIKI for repair.
Sensor abnormalities SENSOR FAIL	A sensor has failed.	Request RIKEN KEIKI for repair.

A low battery voltage alarm is displayed. BATTERY FAIL	The battery level is low.	Turn off the power and replace the dry batteries with new ones in a non-hazardous area.
Fresh air adjustment cannot be performed. AIR FAIL	Fresh air is not supplied around the gas monitor.	Supply fresh air.
Span adjustment cannot be performed. O2 FAIL	Span calibration gas with appropriate concentration is not supplied.	Supply span calibration gas with appropriate concentration.
Clock abnormalities CLOCK FAIL	Abnormalities of the internal clock The gas monitor is left for a long time with the batteries removed (or with dead batteries).	Make a setting of Date/Time. If such a symptom is observed repeatedly, the built-in clock is seemingly malfunctioning.

## Product Specifications

### <Disposal of Batteries>

Detection principle	Galvanic cell type
Gas to be detected *1	O <sub>2</sub>
Concentration display	LCD digital display (seven-segment + symbol)
Detection range	0 to 40.0%
Display resolution	0.1%
Detection method	Diffusion type
Alarm setpoint value	19.5%(1st)/23.5%LEL(2nd)/40%(OVER)
Displays	Battery level icon
Response time (under the same conditions)	90% response: within 20 seconds
Gas alarm type	2 gas alarm (1st/2nd), OVER

Gas alarm display	Lamp blinking, intermittent buzzer sounding, gas concentration display blinking, and vibration
Gas alarm activation	Self-latching (Non latching after reset)
Fault alarm/self diagnosis	System abnormalities, sensor connection abnormalities, battery voltage drop, calibration failure, and clock abnormalities
Fault alarm display	Lamp blinking, intermittent buzzer sounding, and detail display
Functions	LCD backlight, peak display, and data logger
Power supply	AAA alkaline dry batteries x 2 (or AAA Ni-MH batteries <Eneloop> available)
Continuous operating time	About 3000 hours (25°C, no alarm and no lighting, alkaline dry batteries) About 2000 hours (25°C, no alarm and no lighting, Ni-MH batteries, batteries fully charged)
Operating temperature	-20 to +50°C

Operating humidities	0 to 95%RH (Non-condensing)
Explosion-proof of structure	Intrinsically safe explosion-proof structure
Explosion-proof of class *1	II 1GExia II CT4/T3Ga, I M1Exia I Ma
Authentications	ATEX, IECEx
Protection class	Compliant with IP67
External dimensions	Approx. 54 (W) x 67 (H) x 24 (D) mm (projection portions excluded)
Weight	Approx. 80 g (clip excluded)

\* Specifications subject to changes without notice.

\*1 Applicable ignition temperature is T3 for the rechargeable battery type and T4 for the dry battery type.